

## Current Transducer LPSR series

$I_{PN} = 6, 15, 25, 50 A$

Ref: LPSR 6-NP, LPSR 15-NP, LPSR 25-NP, LPSR 50-NP

For the electronic measurement of current: DC, AC, pulsed..., with galvanic separation between the primary and the secondary circuit.



### Features

- Closed loop multi-range current transducer
- Voltage output
- Unipolar supply voltage
- Compact design for PCB mounting
- Overcurrent detect at  $4.1 \times I_{PN}$

### Advantages

- Very low offset drift
- Very good  $du/dt$  immunity
- Reference pin with two modes: Ref IN and Ref OUT
- Extended measuring range for unipolar measurement.

### Applications

- AC variable speed and servo motor drives
- Static converters for DC motor drives
- Battery supplied applications
- Uninterruptible Power Supplies (UPS)
- Switched Mode Power Supplies (SMPS)
- Power supplies for welding applications
- Solar inverters.

### Standards

- IEC 61800-1: 1997
- IEC 61800-2: 2015
- IEC 61800-3: 2004
- IEC 61800-5-1: 2007
- IEC 62109-1: 2010
- IEC 62477-1: 2012
- UL 508:2013.

### Application Domain

- Industrial.

## Absolute maximum ratings

Parameter	Symbol	Unit	Value
Maximum supply voltage	$U_{C \max}$	V	7
Maximum primary conductor temperature	$T_{B \max}$	°C	110
Maximum primary current	$I_{P \max}$	A	$20 \times I_{PN}$
Maximum electrostatic discharge voltage	$U_{ESD \max}$	kV	4

Stresses above these ratings may cause permanent damage. Exposure to absolute maximum ratings for extended periods may degrade reliability.

## UL 508: Ratings and assumptions of certification

File # E189713 Volume: 2 Section: 11

### Standards

- CSA C22.2 NO. 14-10 INDUSTRIAL CONTROL EQUIPMENT - Date 2011/08/01
- UL 508 STANDARD FOR INDUSTRIAL CONTROL EQUIPMENT - Date 2013

### Ratings

Parameter	Symbol	Unit	Value
Primary involved potential		V AC/DC	1000
Max surrounding air temperature	$T_A$	°C	105
Primary current	$I_P$	A	According to series primary currents
Secondary supply voltage	$U_C$	V DC	7
Output voltage	$U_{out}$	V	0 ... 5

### Conditions of acceptability

When installed in the end-use equipment, consideration shall be given to the following:

- 1 - These devices must be mounted in a suitable end-use enclosure.
- 2 - The terminals have not been evaluated for field wiring.
- 3 - The LES, LESR, LKSR, LPSR, LXS and LXSR Series shall be used in a pollution degree 2 environment or better.
- 4 - Low voltage circuits are intended to be powered by a circuit derived from an isolating source (such as a transformer, optical isolator, limiting impedance or electro-mechanical relay) and having no direct connection back to the primary circuit (other than through the grounding means).
- 5 - These devices are intended to be mounted on the printed wiring board of the end-use equipment (with a minimum CTI of 100).
- 6 - LES, LESR, LKSR and LPSR Series: based on results of temperature tests, in the end-use application, a maximum of 110 °C cannot be exceeded on the primary jumper.

### Marking

Only those products bearing the UL or UR Mark should be considered to be Listed or Recognized and covered under UL's Follow-Up Service. Always look for the Mark on the product.

**Insulation coordination**

Parameter	Symbol	Unit	Value	Comment
RMS voltage for AC insulation test, 50 Hz, 1 min	$U_d$	kV	4.3	
Impulse withstand voltage 1.2/50 $\mu$ s	$U_{Ni}$	kV	8	
Insulation resistance	$R_{INS}$	G $\Omega$	18	measured at 500 V DC
Partial discharge RMS test voltage ( $q_m < 10$ pC)	$U_t$	kV	1.65	
Clearance (pri. - sec.)	$d_{Cl}$	mm	8.26	See dimensions drawing on <a href="#">page 20</a>
Creepage distance (pri. - sec.)	$d_{Cp}$			
Case material	-	-	V0	According to UL 94
Comparative tracking index	$CTI$		600	
Application example System voltage		V	600	Reinforced insulation, according to IEC 61800-5-1, CAT III, PD2
Application example System voltage		V	1000	Basic insulation, according to IEC 61800-5-1, CAT III, PD2

**Environmental and mechanical characteristics**

Parameter	Symbol	Unit	Min	Typ	Max	Comment
Ambient operating temperature	$T_A$	$^{\circ}$ C	-40		105	
Ambient storage temperature	$T_{A\text{st}}$	$^{\circ}$ C	-55		125	
Mass	$m$	g		10		

**Electrical data LPSR 6-NP**

At  $T_A = 25\text{ °C}$ ,  $U_C = +5\text{ V}$ ,  $N_P = 1$  turn,  $R_L = 10\text{ k}\Omega$  internal reference, unless otherwise noted (see Definition of typical, minimum and maximum values paragraph in [page 8](#)).

Parameter	Symbol	Unit	Min	Typ	Max	Comment
Primary nominal RMS current	$I_{PN}$	A		6		Apply derating according to <a href="#">figure 21</a>
Primary current, measuring range	$I_{PM}$	A	-20		20	
Number of primary turns	$N_P$			1, 2, 3, 4		
Supply voltage	$U_C$	V	4.75	5	5.25	
Current consumption	$I_C$	mA		$18 + \frac{I_p(\text{mA})}{N_s}$	$20.5 + \frac{I_p(\text{mA})}{N_s}$	$N_s = 2000$ turns
Reference voltage @ $I_P = 0\text{ A}$	$U_{ref}$	V	2.485	2.5	2.515	Internal reference
External reference voltage	$U_{ref}$	V	0.5		2.75	
Output voltage	$U_{out}$	V	0.25		4.75	with $U_C = +5\text{ V}$
Output voltage @ $I_P = 0\text{ A}$	$U_{out}$	V		$U_{ref}$		
Electrical offset voltage	$U_{OE}$	mV	-6.25		6.25	100 % tested $U_{out} - U_{ref}$
Electrical offset current referred to primary	$I_{OE}$	mA	-60		60	100 % tested
Temperature coefficient of $U_{ref}$ @ $I_P = 0\text{ A}$	$TCU_{ref}$	ppm/K			$\pm 70$	Internal reference
Temperature coefficient of $U_{out}$ @ $I_P = 0\text{ A}$	$TCU_{out}$	ppm/K			$\pm 14$	ppm/K of 2.5 V -40 °C ... 105 °C
Nominal sensitivity	$S_N$	mV/A		104.2		625 mV/ $I_{PN}$
Sensitivity error	$\epsilon_S$	%	-0.2		0.2	100 % tested
Temperature coefficient of $S$	$TCS$	ppm/K			$\pm 40$	-40 °C ... 105 °C
Linearity error	$\epsilon_L$	% of $I_{PN}$	-0.1		0.1	
Magnetic offset current ( $10 \times I_{PN}$ ) referred to primary	$I_{OM}$	mA	-25		25	
Noise voltage spectral density 100 ... 100 kHz referred to primary	$u_{no}$	$\mu\text{V}/\text{Hz}^{1/2}$		7		
Peak-to-peak noise voltage DC ... 10 kHz DC ... 100 kHz DC ... 1 MHz	$U_{no pp}$	mVpp		10.5 13.4 13.6		
Primary current, detection threshold	$I_{PTh}$	A	$4.02 \times I_{PN}$	$4.1 \times I_{PN}$	$4.17 \times I_{PN}$	
OCD detection delay time	$t_{DOCD}$	$\mu\text{s}$		1.4	2.2	Overcurrent detection measured over temperature -40 °C ... 105 °C with an $I_P$ step of $5 \times I_{PN}$ and $di/dt = 50\text{ A}/\mu\text{s}$
OCD output hold time	$t_{hold\ OCD}$	ms			1	
Delay time to 10 % of the final output value for $I_{PN}$ step	$t_{D10}$	$\mu\text{s}$			0.3	$R_L = 1\text{ k}\Omega$ , $di/dt = 50\text{ A}/\mu\text{s}$
Delay time to 90 % of the final output value for $I_{PN}$ step	$t_{D90}$	$\mu\text{s}$			0.4	$R_L = 1\text{ k}\Omega$ , $di/dt = 50\text{ A}/\mu\text{s}$
Frequency bandwidth ( $\pm 1\text{ dB}$ )	$BW$	kHz	300			$R_L = 1\text{ k}\Omega$
Total error	$\epsilon_{tot}$	% of $I_{PN}$			1.25	
Total error @ $T_A = 85\text{ °C}$ (105 °C)	$\epsilon_{tot}$	% of $I_{PN}$			1.25 (1.5)	
Error	$\epsilon$	% of $I_{PN}$			0.45	
Error @ $T_A = 85\text{ °C}$ (105 °C)	$\epsilon$	% of $I_{PN}$			0.75 (1)	

**Electrical data LPSR 15-NP**

At  $T_A = 25\text{ °C}$ ,  $U_C = +5\text{ V}$ ,  $N_P = 1\text{ turn}$ ,  $R_L = 10\text{ k}\Omega$  internal reference, unless otherwise noted (see Definition of typical, minimum and maximum values paragraph in [page 8](#)).

Parameter	Symbol	Unit	Min	Typ	Max	Comment
Primary nominal RMS current	$I_{PN}$	A		15		Apply derating according to <a href="#">figure 22</a>
Primary current, measuring range	$I_{PM}$	A	-51		51	
Number of primary turns	$N_P$			1, 2, 3, 4		
Supply voltage	$U_C$	V	4.75	5	5.25	
Current consumption	$I_C$	mA		$18 + \frac{I_p(\text{mA})}{N_s}$	$20.5 + \frac{I_p(\text{mA})}{N_s}$	$N_s = 2000\text{ turns}$
Reference voltage @ $I_p = 0\text{ A}$	$U_{ref}$	V	2.485	2.5	2.515	Internal reference
External reference voltage	$U_{ref}$	V	0.5		2.75	
Output voltage	$U_{out}$	V	0.25		4.75	with $U_C = +5\text{ V}$
Output voltage @ $I_p = 0\text{ A}$	$U_{out}$	V		$U_{ref}$		
Electrical offset voltage	$U_{OE}$	mV	-2.5		2.5	100 % tested $U_{out} - U_{ref}$
Electrical offset current referred to primary	$I_{OE}$	mA	-60		60	100 % tested
Temperature coefficient of $U_{ref}$ @ $I_p = 0\text{ A}$	$TCU_{ref}$	ppm/K			$\pm 70$	Internal reference
Temperature coefficient of $U_{out}$ @ $I_p = 0\text{ A}$	$TCU_{out}$	ppm/K			$\pm 6$	ppm/K of 2.5 V -40 °C ... 105 °C
Nominal sensitivity	$S_N$	mV/A		41.67		$625\text{ mV}/I_{PN}$
Sensitivity error	$\epsilon_S$	%	-0.2		0.2	100 % tested
Temperature coefficient of $S$	$TCS$	ppm/K			$\pm 40$	-40 °C ... 105 °C
Linearity error	$\epsilon_L$	% of $I_{PN}$	-0.1		0.1	
Magnetic offset current ( $10 \times I_{PN}$ ) referred to primary	$I_{OM}$	mA	-45		45	
Noise voltage spectral density 100 ... 100 kHz referred to primary	$u_{no}$	$\mu\text{V}/\text{Hz}^{1/2}$		3.5		
Peak-to-peak noise voltage DC ... 10 kHz DC ... 100 kHz DC ... 1 MHz	$U_{no\text{pp}}$	mVpp		4.5 5.7 6.3		
Primary current, detection threshold	$I_{PTh}$	A	$4.02 \times I_{PN}$	$4.1 \times I_{PN}$	$4.17 \times I_{PN}$	
OCD detection delay time	$t_{D\text{OCD}}$	$\mu\text{s}$		1.4	2.2	Overcurrent detection measured over temperature -40 °C ... 105 °C with an $I_p$ step of $5 \times I_{PN}$ and $di/dt = 50\text{ A}/\mu\text{s}$
OCD output hold time	$t_{\text{hold\text{OCD}}}$	ms			1	
Delay time to 10 % of the final output value for $I_{PN}$ step	$t_{D10}$	$\mu\text{s}$			0.3	$R_L = 1\text{ k}\Omega$ , $di/dt = 50\text{ A}/\mu\text{s}$
Delay time to 90 % of the final output value for $I_{PN}$ step	$t_{D90}$	$\mu\text{s}$			0.4	$R_L = 1\text{ k}\Omega$ , $di/dt = 50\text{ A}/\mu\text{s}$
Frequency bandwidth ( $\pm 3\text{ dB}$ )	$BW$	kHz	300			$R_L = 1\text{ k}\Omega$
Total error	$\epsilon_{\text{tot}}$	% of $I_{PN}$			0.7	
Total error @ $T_A = 85\text{ °C}$ (105 °C)	$\epsilon_{\text{tot}}$	% of $I_{PN}$			0.7 (1)	
Error	$\epsilon$	% of $I_{PN}$			0.45	
Error @ $T_A = 85\text{ °C}$ (105 °C)	$\epsilon$	% of $I_{PN}$			0.65 (0.75)	

**Electrical data LPSR 25-NP**

At  $T_A = 25\text{ °C}$ ,  $U_C = +5\text{ V}$ ,  $N_P = 1$  turn,  $R_L = 10\text{ k}\Omega$  internal reference, unless otherwise noted (see Definition of typical, minimum and maximum values paragraph in [page 8](#)).

Parameter	Symbol	Unit	Min	Typ	Max	Comment
Primary nominal RMS current	$I_{PN}$	A		25		Apply derating according to <a href="#">figure 23</a>
Primary current, measuring range	$I_{PM}$	A	-85		85	
Number of primary turns	$N_P$			1, 2, 3, 4		
Supply voltage	$U_C$	V	4.75	5	5.25	
Current consumption	$I_C$	mA		$18 + \frac{I_p(\text{mA})}{N_s}$	$20.5 + \frac{I_p(\text{mA})}{N_s}$	$N_s = 2000$ turns
Reference voltage @ $I_P = 0\text{ A}$	$U_{ref}$	V	2.485	2.5	2.515	Internal reference
External reference voltage	$U_{ref}$	V	0.5		2.75	
Output voltage	$U_{out}$	V	0.25		4.75	with $U_C = +5\text{ V}$
Output voltage @ $I_P = 0\text{ A}$	$U_{out}$	V		$U_{ref}$		
Electrical offset voltage	$U_{OE}$	mV	-1.5		1.5	100 % tested $U_{out} - U_{ref}$
Electrical offset current referred to primary	$I_{OE}$	mA	-60		60	100 % tested
Temperature coefficient of $U_{ref}$ @ $I_P = 0\text{ A}$	$TCU_{ref}$	ppm/K			$\pm 70$	Internal reference
Temperature coefficient of $U_{out}$ @ $I_P = 0\text{ A}$	$TCU_{out}$	ppm/K			$\pm 4$	ppm/K of 2.5 V -40 °C ... 105 °C
Nominal sensitivity	$S_N$	mV/A		25		$625\text{ mV}/I_{PN}$
Sensitivity error	$\epsilon_s$	%	-0.2		0.2	100 % tested
Temperature coefficient of $S$	$TCS$	ppm/K			$\pm 40$	-40 °C ... 105 °C
Linearity error	$\epsilon_L$	% of $I_{PN}$	-0.1		0.1	
Magnetic offset current ( $10 \times I_{PN}$ ) referred to primary	$I_{OM}$	mA	-60		60	
Noise voltage spectral density 100 ... 100 kHz referred to primary	$u_{no}$	$\mu\text{V}/\text{Hz}^{1/2}$		1.8		
Peak-to-peak noise voltage DC ... 10 kHz DC ... 100 kHz DC ... 1 MHz	$U_{no\text{pp}}$	mVpp		2.6 3.9 5.1		
Primary current, detection threshold	$I_{PTh}$	A	$4.02 \times I_{PN}$	$4.1 \times I_{PN}$	$4.17 \times I_{PN}$	
OCD detection delay time	$t_{D\text{OCD}}$	$\mu\text{s}$		1.4	2.2	Overcurrent detection measured over temperature -40 °C ... 105 °C with an $I_P$ step of $5 \times I_{PN}$ and $di/dt = 50\text{ A}/\mu\text{s}$
OCD output hold time	$t_{\text{hold OCD}}$	ms			1	
Delay time to 10 % of the final output value for $I_{PN}$ step	$t_{D10}$	$\mu\text{s}$			0.3	$R_L = 1\text{ k}\Omega$ , $di/dt = 50\text{ A}/\mu\text{s}$
Delay time to 90 % of the final output value for $I_{PN}$ step	$t_{D90}$	$\mu\text{s}$			0.4	$R_L = 1\text{ k}\Omega$ , $di/dt = 50\text{ A}/\mu\text{s}$
Frequency bandwidth ( $\pm 3\text{ dB}$ )	$BW$	kHz	300			$R_L = 1\text{ k}\Omega$
Total error	$\epsilon_{\text{tot}}$	% of $I_{PN}$			0.75	
Total error @ $T_A = 85\text{ °C}$ (105 °C)	$\epsilon_{\text{tot}}$	% of $I_{PN}$			0.85 (0.9)	
Error	$\epsilon$	% of $I_{PN}$			0.45	
Error @ $T_A = 85\text{ °C}$ (105 °C)	$\epsilon$	% of $I_{PN}$			0.65 (0.75)	

**Electrical data LPSR 50-NP**

At  $T_A = 25\text{ °C}$ ,  $U_C = +5\text{ V}$ ,  $N_P = 1\text{ turn}$ ,  $R_L = 10\text{ k}\Omega$  internal reference, unless otherwise noted (see Definition of typical, minimum and maximum values paragraph in [page 8](#)).

Parameter	Symbol	Unit	Min	Typ	Max	Comment
Primary nominal RMS current	$I_{PN}$	A		50		Apply derating according to <a href="#">figure 24</a>
Primary current, measuring range	$I_{PM}$	A	-150		150	
Number of primary turns	$N_P$			1, 2, 3, 4		
Supply voltage	$U_C$	V	4.75	5	5.25	
Current consumption	$I_C$	mA		$18 + \frac{I_r(\text{mA})}{N_s}$	$20.5 + \frac{I_r(\text{mA})}{N_s}$	$N_s = 1600\text{ turns}$
Reference voltage @ $I_P = 0\text{ A}$	$U_{ref}$	V	2.485	2.5	2.515	Internal reference
External reference voltage	$U_{ref}$	V	0.5		2.75	
Output voltage	$U_{out}$	V	0.25		4.75	with $U_C = +5\text{ V}$
Output voltage @ $I_P = 0\text{ A}$	$U_{out}$	V		$U_{ref}$		
Electrical offset voltage	$U_{OE}$	mV	-0.875		0.875	100 % tested $U_{out} - U_{ref}$
Electrical offset current referred to primary	$I_{OE}$	mA	-70		70	100 % tested
Temperature coefficient of $U_{ref}$ @ $I_P = 0\text{ A}$	$TCU_{ref}$	ppm/K			$\pm 70$	Internal reference
Temperature coefficient of $U_{out}$ @ $I_P = 0\text{ A}$	$TCU_{out}$	ppm/K			$\pm 3$	ppm/K of 2.5 V -40 °C ... 105 °C
Nominal sensitivity	$S_N$	mV/A		12.5		$625\text{ mV}/I_{PN}$
Sensitivity error	$\epsilon_S$	%	-0.2		0.2	100 % tested
Temperature coefficient of $S$	$TCS$	ppm/K			$\pm 40$	-40 °C ... 105 °C
Linearity error	$\epsilon_L$	% of $I_{PN}$	-0.1		0.1	
Magnetic offset current ( $10 \times I_{PN}$ ) referred to primary	$I_{OM}$	mA	-60		60	
Noise voltage spectral density 100 ... 100 kHz referred to primary	$u_{no}$	$\mu\text{V}/\text{Hz}^{1/2}$		1.7		
Peak-to-peak noise voltage DC ... 10 kHz DC ... 100 kHz DC ... 1 MHz	$U_{no\text{pp}}$	mVpp		2.4 3.2 4.8		
Primary current, detection threshold	$I_{PTh}$	A	$4.02 \times I_{PN}$	$4.1 \times I_{PN}$	$4.17 \times I_{PN}$	
OCD detection delay time	$t_{DOCD}$	$\mu\text{s}$		1.4	2.2	Overcurrent detection measured over temperature -40 °C ... 105 °C with an $I_P$ step of $5 \times I_{PN}$ and $di/dt = 50\text{ A}/\mu\text{s}$
OCD output hold time	$t_{hold\text{OCD}}$	ms			1	
Delay time to 10 % of the final output value for $I_{PN}$ step	$t_{D10}$	$\mu\text{s}$			0.3	$R_L = 1\text{ k}\Omega$ , $di/dt = 50\text{ A}/\mu\text{s}$
Delay time to 90 % of the final output value for $I_{PN}$ step	$t_{D90}$	$\mu\text{s}$			0.4	$R_L = 1\text{ k}\Omega$ , $di/dt = 50\text{ A}/\mu\text{s}$
Frequency bandwidth ( $\pm 3\text{ dB}$ )	$BW$	kHz	300			$R_L = 1\text{ k}\Omega$
Total error	$\epsilon_{tot}$	% of $I_{PN}$			0.65	
Total error @ $T_A = 85\text{ °C}$ (105 °C)	$\epsilon_{tot}$	% of $I_{PN}$			0.7 (0.8)	
Error	$\epsilon$	% of $I_{PN}$			0.45	
Error @ $T_A = 85\text{ °C}$ (105 °C)	$\epsilon$	% of $I_{PN}$			0.65 (0.75)	

## **Definition of typical, minimum and maximum values**

Minimum and maximum values for specified limiting and safety conditions have to be understood as such as well as values shown in “typical” graphs.

On the other hand, measured values are part of a statistical distribution that can be specified by an interval with upper and lower limits and a probability for measured values to lie within this interval.

Unless otherwise stated (e.g. “100 % tested”), the LEM definition for such intervals designated with “min” and “max” is that the probability for values of samples to lie in this interval is 99.73 %.

For a normal (Gaussian) distribution, this corresponds to an interval between  $-3$  sigma and  $+3$  sigma. If “typical” values are not obviously mean or average values, those values are defined to delimit intervals with a probability of 68.27 %, corresponding to an interval between  $-\text{sigma}$  and  $+\text{sigma}$  for a normal distribution.

Typical, maximal and minimal values are determined during the initial characterization of the product.



Typical performance characteristics LPSR 6-NP

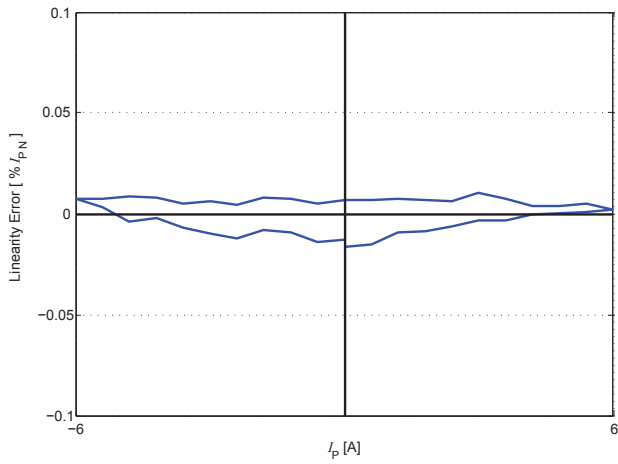

Figure 1: Linearity error

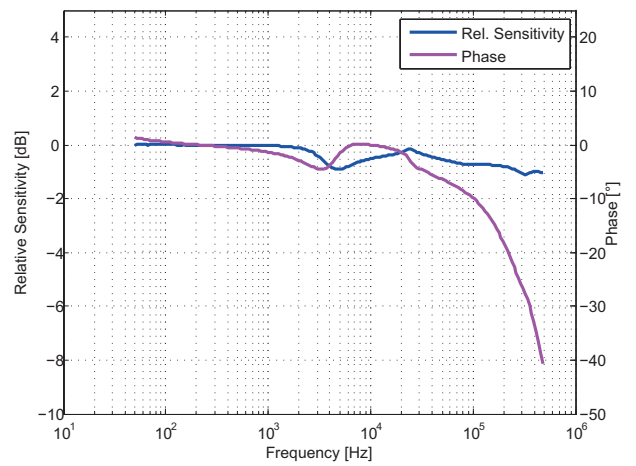

Figure 2: Frequency response

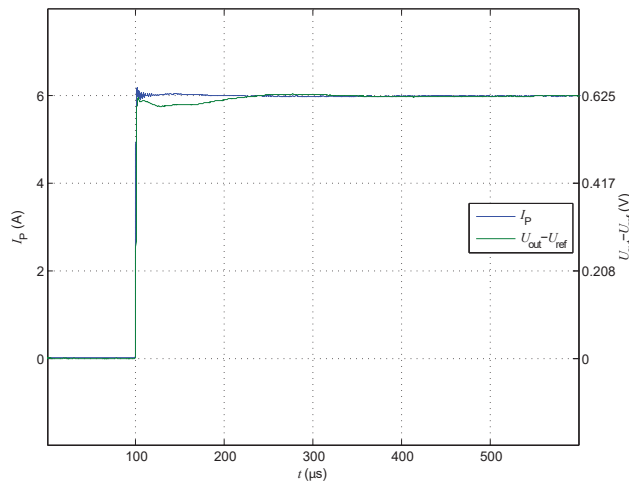

Figure 3: Delay time

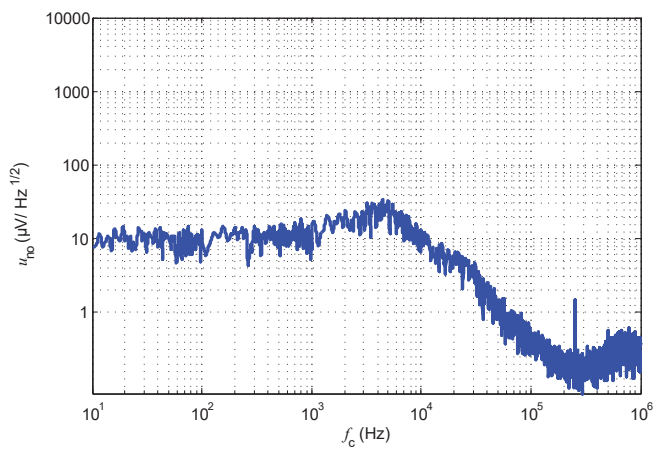

Figure 4: Noise voltage spectral density

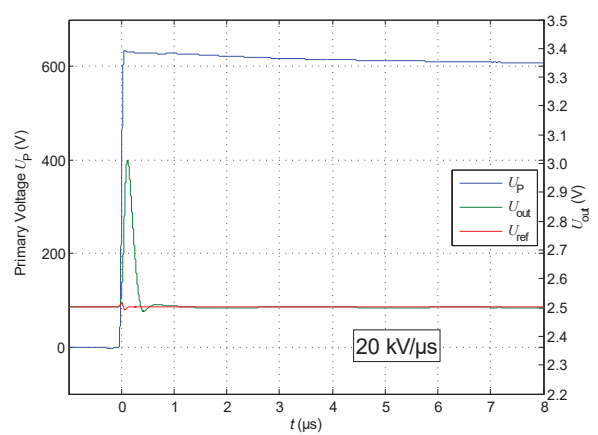

Figure 5: du/dt

Typical performance characteristics LPSR 15-NP

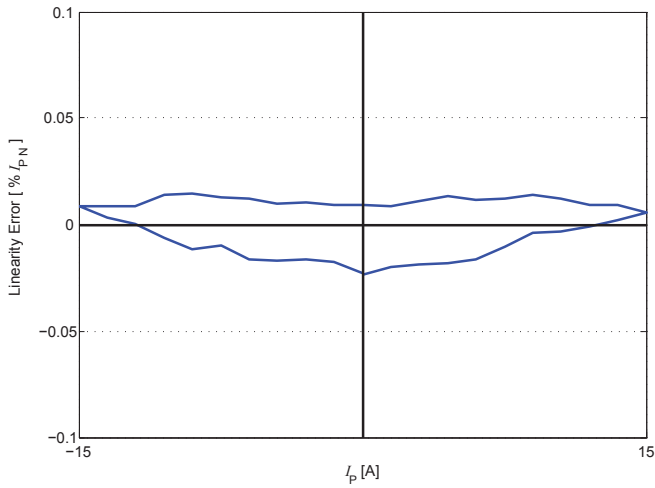

Figure 6: Linearity error

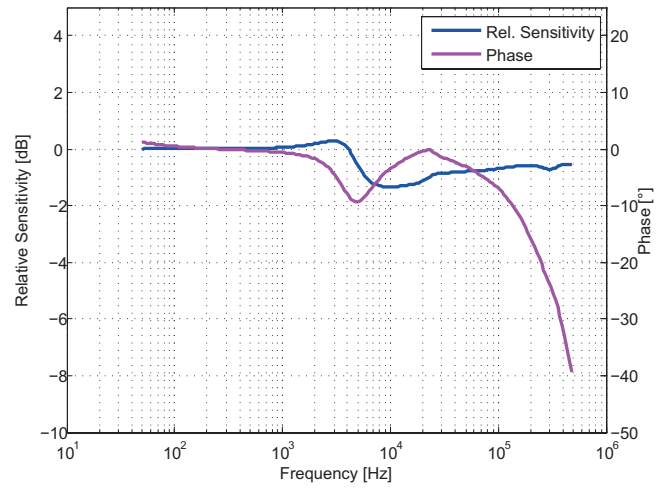

Figure 7: Frequency response

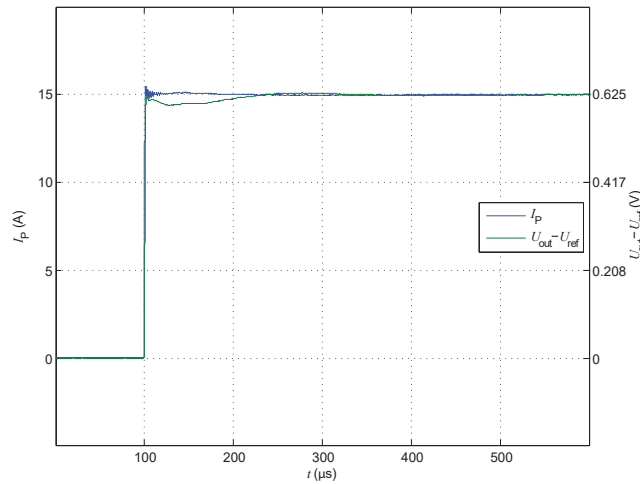

Figure 8: Delay time

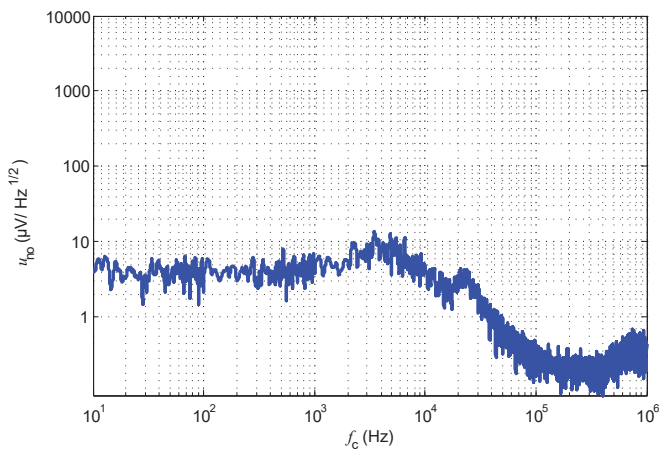

Figure 9: Noise voltage spectral density

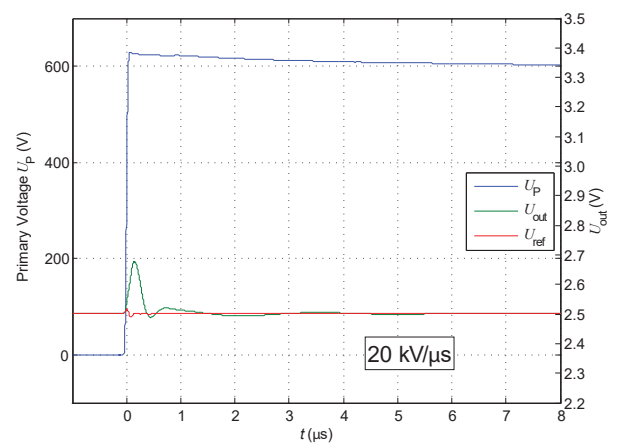

Figure 10: du/dt

Typical performance characteristics LPSR 25-NP

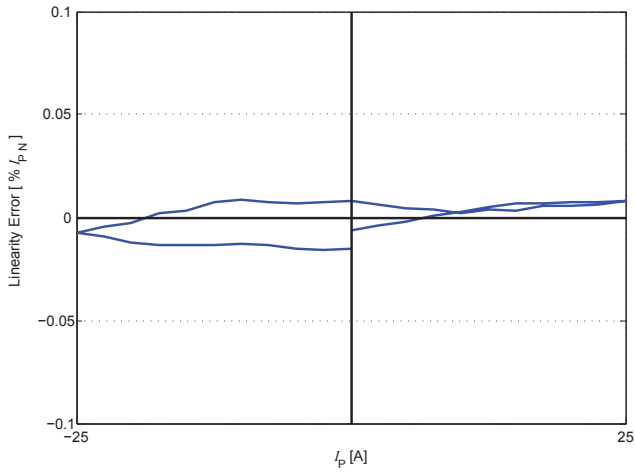

Figure 11: Linearity error

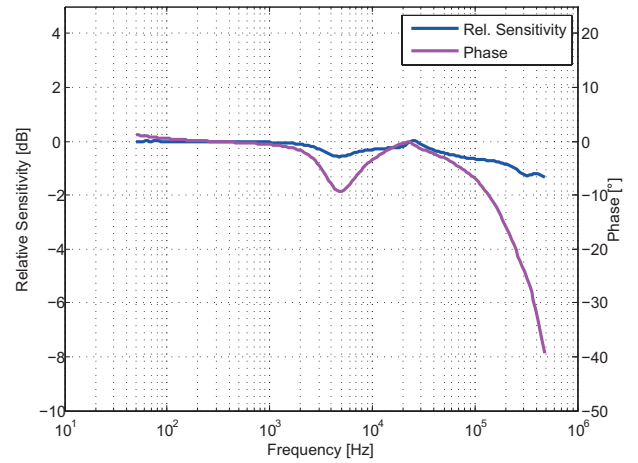

Figure 12: Frequency response

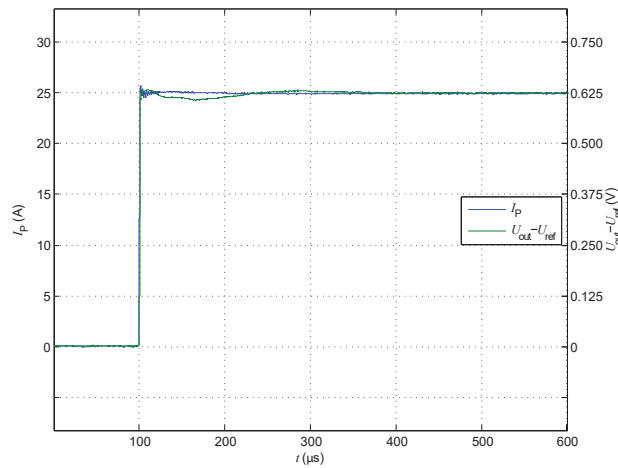

Figure 13: Delay time

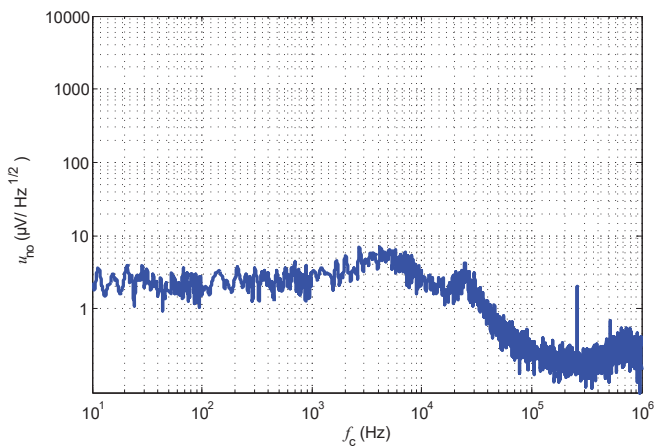

Figure 14: Noise voltage spectral density

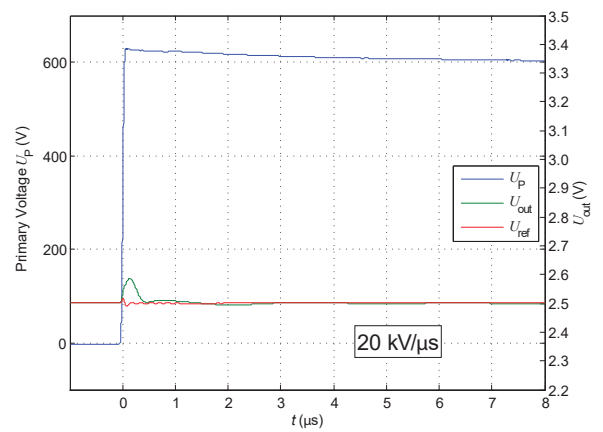

Figure 15: du/dt

Typical performance characteristics LPSR 50-NP

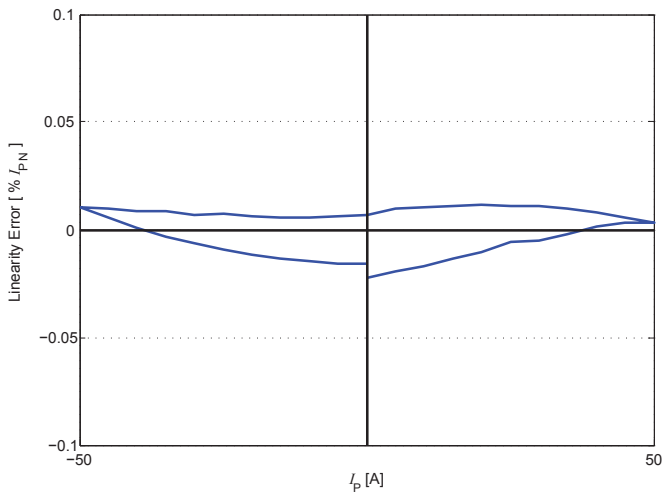

Figure 16: Linearity error

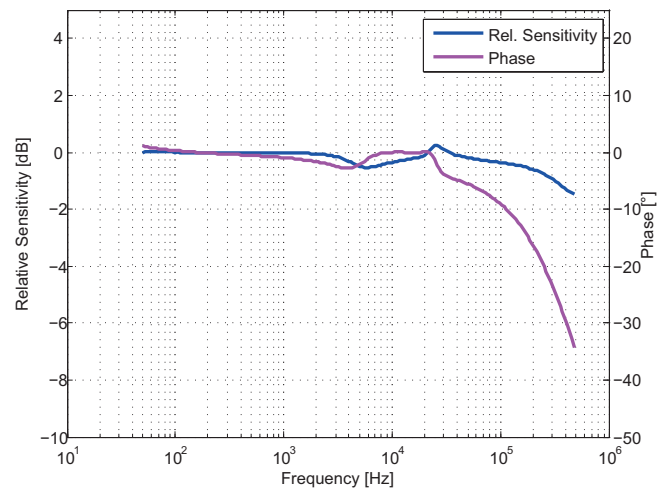

Figure 17: Frequency response

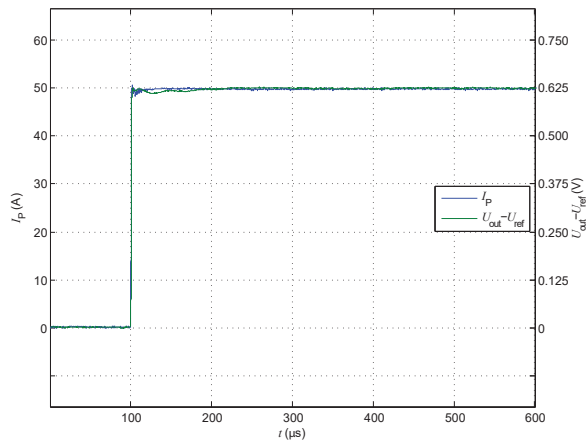

Figure 18: Delay time

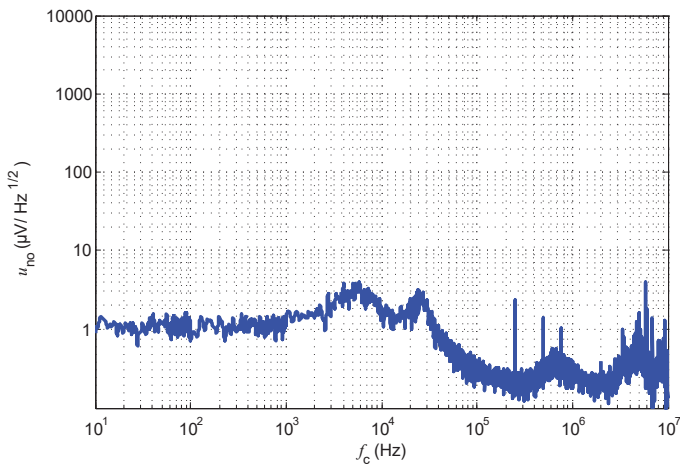

Figure 19: Noise voltage spectral density

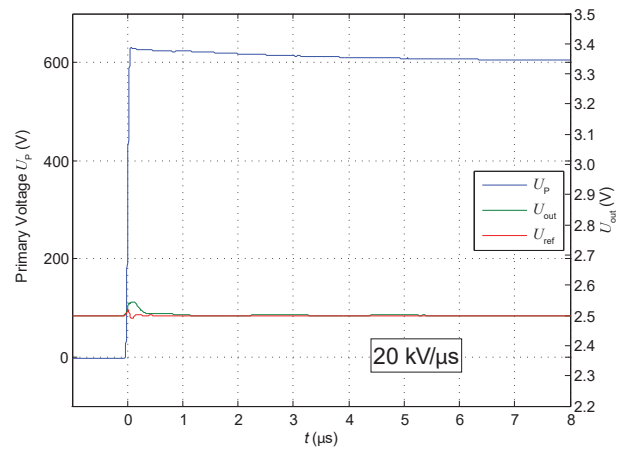

Figure 20:  $du/dt$

Maximum continuous DC primary current

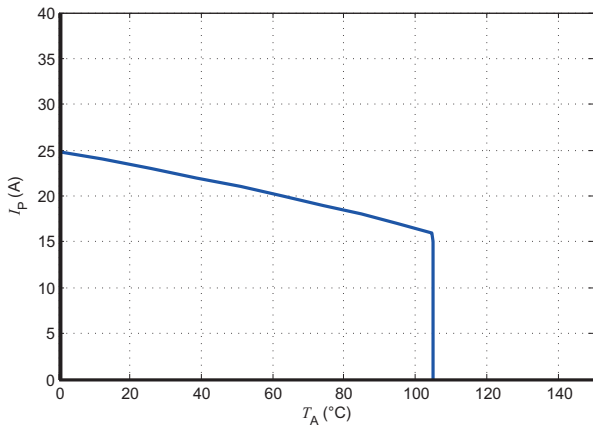

Figure 21:  $I_p$  vs  $T_A$  for LPSR 6-NP

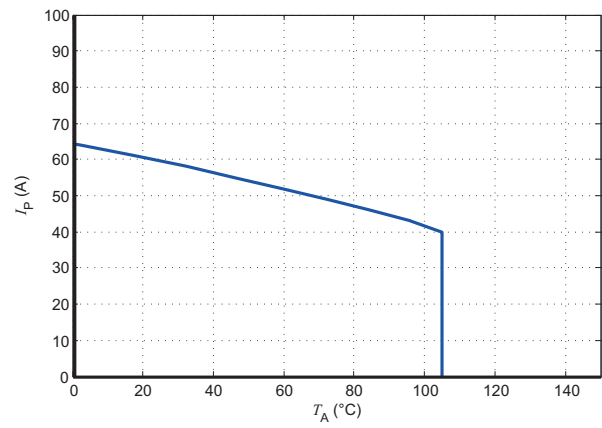

Figure 22:  $I_p$  vs  $T_A$  for LPSR 15-NP

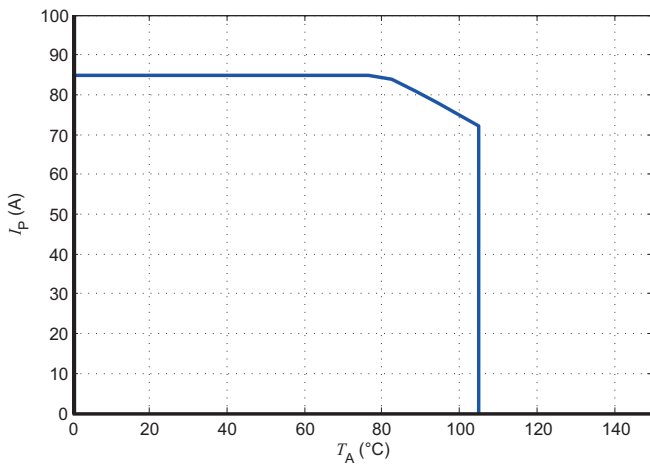

Figure 23:  $I_p$  vs  $T_A$  for LPSR 25-NP

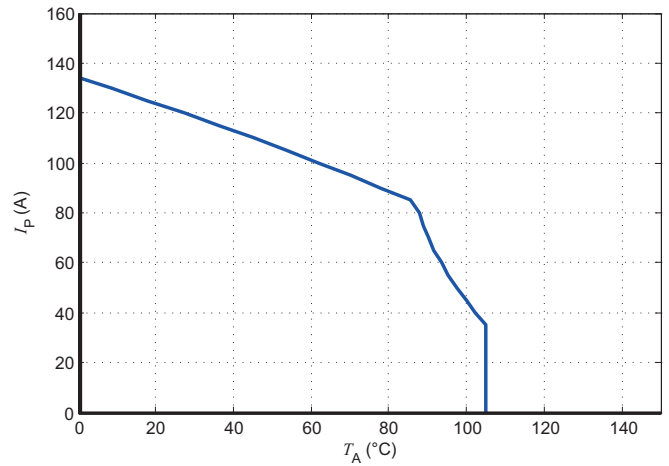

Figure 24:  $I_p$  vs  $T_A$  for LPSR 50-NP

The maximum continuous DC primary current plot shows the boundary of the area for which all the following conditions are true:

- $I_p < I_{pM}$
- Junction temperature  $T_j < 125$  °C
- Primary conductor temperature  $< 110$  °C
- Max power dissipation of internal resistors  $< 0.5 \times$  resistors nominal power.

Frequency derating

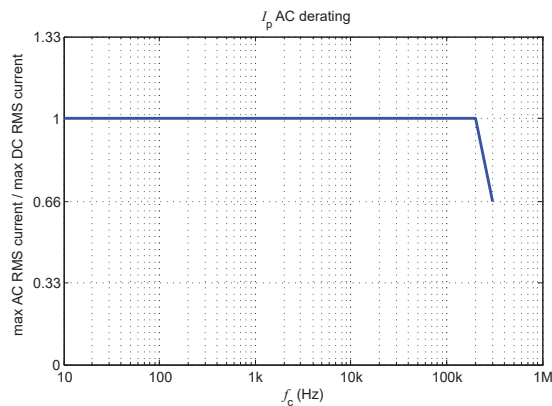

Figure 25: Maximum RMS AC primary current / maximum DC primary current vs frequency

## Performance parameters definition

### Ampere-turns and amperes

The transducer is sensitive to the primary current linkage  $\theta_p$  (also called ampere-turns).

$$\theta_p = N_p \cdot I_p \text{ (At)}$$

Where  $N_p$  is the number of primary turn (depending on the connection of the primary jumpers)

Caution: As most applications will use the transducer with only one single primary turn ( $N_p = 1$ ), much of this datasheet is written in terms of primary current instead of current linkages. However, the ampere-turns (At) unit is used to emphasis that current linkages are intended and applicable.

### Simplified transducer model

The static model of the transducer at temperature  $T_A$  is:

$$U_{out} = S \cdot \theta_p + \varepsilon$$

In which  $\varepsilon =$

$$U_{OE} + U_{OT}(T_A) + \varepsilon_s \cdot \theta_p \cdot S + \varepsilon_L(\theta_{Pmax}) \cdot \theta_{Pmax} \cdot S + TCS \cdot (T_A - 25) \cdot \theta_p \cdot S$$

- With:
- $\theta_p = N_p \cdot I_p$  : primary current linkage (At)
  - $\theta_{Pmax}$  : max primary current linkage applied to the transducer
  - $U_{out}$  : Output voltage (V)
  - $T_A$  : ambient operating temperature (°C)
  - $U_{OE}$  : electrical offset voltage (V)
  - $U_{OT}(T_A)$  : temperature variation of  $U_O$  at temperature  $T_A$  (°C)
  - $S$  : sensitivity of the transducer (V/At)
  - $TCS$  : temperature coefficient of  $S$
  - $\varepsilon_s$  : sensitivity error
  - $\varepsilon_L(\theta_{Pmax})$  : linearity error for  $\theta_{Pmax}$

This model is valid for primary ampere-turns  $\theta_p$  between  $-\theta_{Pmax}$  and  $+\theta_{Pmax}$  only.

### Total error

The total error at 25 °C  $\varepsilon_{tot}$  is the error in the  $-I_{PN} \dots +I_{PN}$  range, relative to the rated value  $I_{PN}$ .

It includes:

- the electrical offset  $U_{OE}$
- the sensitivity error  $\varepsilon_s$
- the linearity error  $\varepsilon_L$  (to  $I_{PN}$ )

### Electrical offset

The electrical offset voltage  $U_{OE}$  can either be measured when the ferro-magnetic parts of the transducer are:

- Completely demagnetized, which is difficult to realize, or
- in a known magnetization state, like in the current cycle shown in figure 27.

Using the current cycle shown in figure 27, the electrical offset is:

$$U_{OE} = \frac{U_{out}(t_1) + U_{out}(t_2)}{2}$$

The temperature variation  $U_{OT}$  of the electrical offset voltage  $U_{OE}$  is the variation of the electrical offset from 25 °C to the considered temperature:

$$U_{OT}(T) = U_{OE}(T) - U_{OE}(25 \text{ °C})$$

Note: the transducer has to be demagnetized prior to the application of the current cycle (for example with a demagnetization tunnel).

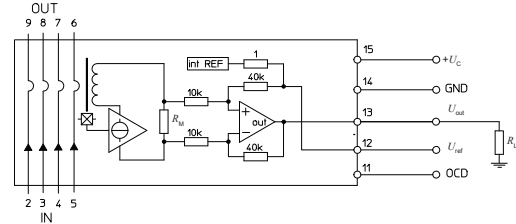

Figure 26: Test connection

### Magnetic offset

The magnetic offset current  $I_{OM}$  is the consequence of a current on the primary side (“memory effect” of the transducer’s ferromagnetic parts). It is measured using the following primary current cycle.  $I_{OM}$  depends on the current value  $I_{P1}$  ( $I_{P1} > I_{PM}$ ).

$$I_{OM} = \frac{U_{out}(t_1) - U_{out}(t_2)}{2} \cdot \frac{1}{S_N}$$

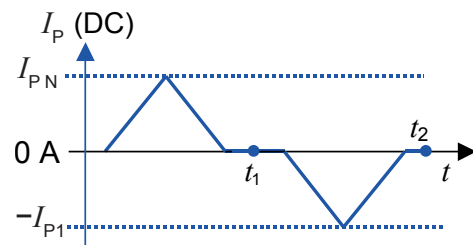

Figure 27: Current cycle used to measure magnetic and electrical offset (transducer supplied)

## Performance parameters definition

### Sensitivity and linearity

To measure sensitivity and linearity, the primary current (DC) is cycled from 0 to  $I_p$ , then to  $-I_p$  and back to 0 (equally spaced  $I_p/10$  steps). The sensitivity  $S$  is defined as the slope of the linear regression line for a cycle between  $\pm I_{PN}$ .

The linearity error  $\epsilon_L$  is the maximum positive or negative difference between the measured points and the linear regression line, expressed in % of  $I_{PN}$ .

### Delay times

The delay time  $t_{D,10}$  @ 10 % and the delay time  $t_{D,90}$  @ 90 % are shown in figure 28.

Both depend on the primary current  $di/dt$ . They are measured at nominal ampere-turns.

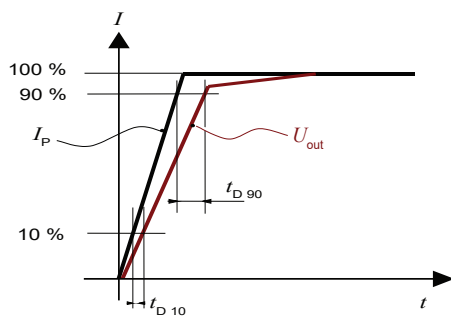

Figure 28:  $t_{D,10}$  (delay time @ 10 %) and  $t_{D,90}$  (delay time @ 90 %)

## Application information

### Filtering and decoupling

#### Supply voltage $U_C$

The transducer has internal decoupling capacitors, but in the case of a power supply with high impedance, it is highly recommended to provide local decoupling (100 nF or more, located close to the transducer) as it may reduce disturbance on transducer output  $U_{out}$  and reference  $U_{ref}$  due to high varying primary current. The transducer power supply rejection ratio is low at high frequency.

#### Output $U_{out}$

The output  $U_{out}$  has a very low output impedance of typically 1 Ohm; it can drive capacitive loads of up to 100 nF directly. Adding series resistance  $R_f$  of several tenths of Ohms allows much larger capacitive loads  $C_f$  (higher than 1  $\mu$ F). Empirical evaluation may be necessary to obtain optimum results. The minimum load resistance on  $U_{out}$  is 1 kOhm.

#### Total Primary Resistance

The primary resistance is 0.72 m $\Omega$  per conductor.

In the following table, examples of primary resistance according to the number of primary turns.

Number of primary turns	Primary Nominal RMS current	Output voltage $U_{out}$	Primary resistance $R_p$ [m $\Omega$ ]	Recommended connections
1	$\pm I_{PN}$	$U_{ref} \pm 0.625$	0.18	
2	$\pm I_{PN}/2$	$U_{ref} \pm 0.625$	0.72	
3	$\pm I_{PN}/3$	$U_{ref} \pm 0.625$	1.8	
4	$\pm I_{PN}/4$	$U_{ref} \pm 0.625$	2.88	

#### Reference $U_{ref}$

Like the output  $U_{out}$ , the  $U_{ref}$  has a very low output impedance of typically 1 Ohm; it can drive capacitive loads of up to 100 nF directly. Adding series resistance  $R_f$  of several tenths of Ohms allows much larger capacitive loads  $C_f$  (higher than 1  $\mu$ F). Empirical evaluation may be necessary to obtain optimum results. The minimum load resistance on  $U_{ref}$  is 10 kOhms.

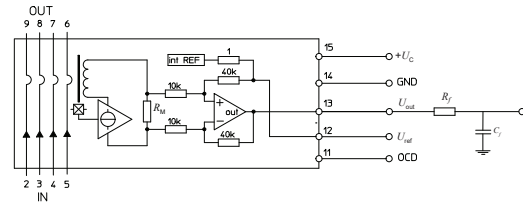

Figure 29: Filtered  $U_{out}$  connection



### External reference voltage

The REF pin can be used either as a reference voltage output or as a reference voltage input.  
 When used in reference voltage output, the internal reference voltage  $U_{ref}$  is used by the transducer as the reference point for bipolar measurements.  
 The internal reference voltage output accuracy is defined in the electrical parameter data.  
 When used in reference voltage input, an external reference voltage is connected to the REF pin.  
 In this case, the maximum allowable reference voltage range is 0.5 V - 2.75 V.  
 The REF pin must be able to source or sink an input current of 1.5 mA maximum.  
 If the reference voltage is not used, the REF pin should be left unconnected.

The following graphs show how the measuring range of each transducer version depends on the external reference voltage value  $U_{ref}$ .

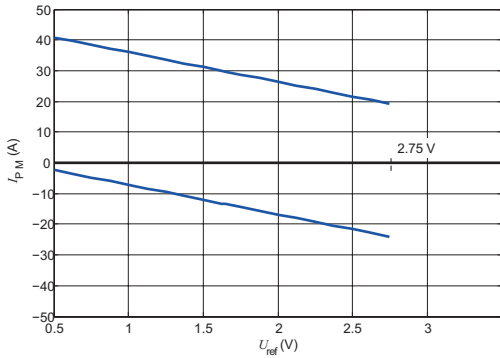

Figure 30: Measuring range versus external  $U_{ref}$  LPSR 6 A

Upper limit:  $I_p = -9.6 * U_{ref} + 45.6$  ( $U_{ref} = 0.5 \dots 2.75$  V)

Lower limit:  $I_p = -9.6 * U_{ref} + 2.4$  ( $U_{ref} = 0.5 \dots 2.75$  V)

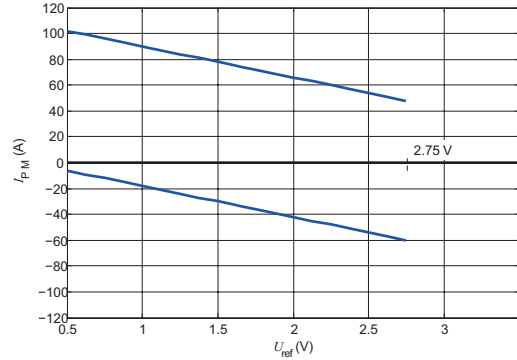

Figure 31: Measuring range versus external  $U_{ref}$  LPSR 15 A

Upper limit:  $I_p = -24 * U_{ref} + 114$  ( $U_{ref} = 0.5 \dots 2.75$  V)

Lower limit:  $I_p = -24 * U_{ref} + 6$  ( $U_{ref} = 0 \dots 2.75$  V)

External reference voltage

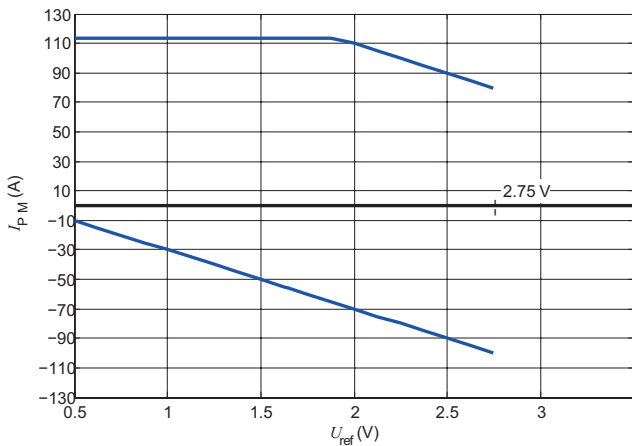

Figure 32: Measuring range versus external  $U_{ref}$  LPSR 25 A

Upper limit:  $I_p = -40 * U_{ref} + 190$  ( $U_{ref} = 1.85 \dots 2.75$  V)

Upper limit:  $I_p = 113$  ( $U_{ref} = 0 \dots 1.85$  V)

Lower limit:  $I_p = -40 * U_{ref} + 10$  ( $U_{ref} = 0 \dots 2.75$  V)

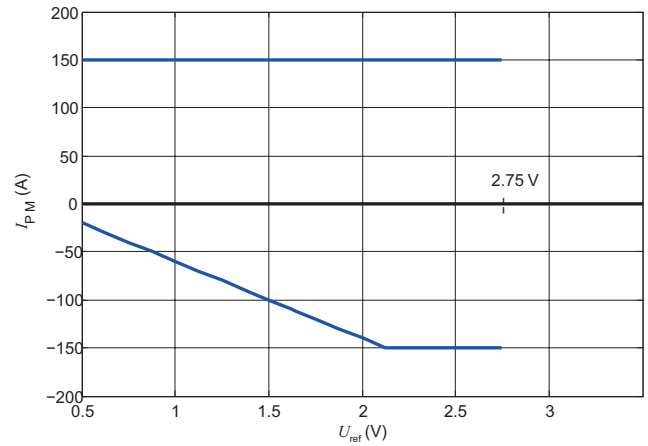

Figure 33: Measuring range versus external  $U_{ref}$  LPSR 50 A

Upper limit:  $I_p = 150$  ( $U_{ref} = 0 \dots 2.125$  V)

Lower limit:  $I_p = -80 * U_{ref} + 20$  ( $U_{ref} = 0 \dots 2.125$  V)

Lower limit:  $I_p = -150$  ( $U_{ref} = 2.125 \dots 2.75$  V)

Example with  $U_{ref} = 1.65$  V:

- The 6 A version has a measuring range from -13.44 A to +29.76 A
- The 15 A version has a measuring range from -33.6 A to +74.4 A
- The 25 A version has a measuring range from -56 A to +113 A
- The 50 A version has a measuring range from -112 A to +150 A

Example with  $U_{ref} = 0.5$  V:

- The 6 A version has a measuring range from -2.4 A to +40.8 A
- The 15 A version has a measuring range from -6 A to +102 A
- The 25 A version has a measuring range from -10 A to +113 A
- The 50 A version has a measuring range from -20 A to +150 A

Overcurrent detection definition

The overcurrent detection function generates an output signal to the OCD pin whenever the primary current exceeds a pre-programmed threshold value. Once the overcurrent event is detected, the CMOS-type OCD signal changes from low logic (< 30 %  $U_C$ ) to high logic value (> 70 %  $U_C$ ). In order to avoid undesirable glitches, the OCD signal is digitally filtered and the OCD signal output is held for 1 ms in high logic value after the last overcurrent event detection.

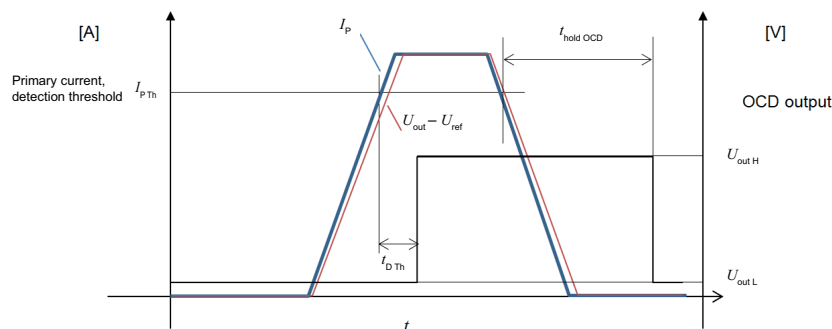

Parameter	Symbol	Unit	Min	Typ	Max	Comment
High-level output voltage	$U_{outH}$	V	3.5			With $U_C = +5$ V and source current of 3 mA
Low-level output voltage	$U_{outL}$	V			1.5	With $U_C = +5$ V and sink current of 3 mA

### PCB footprint

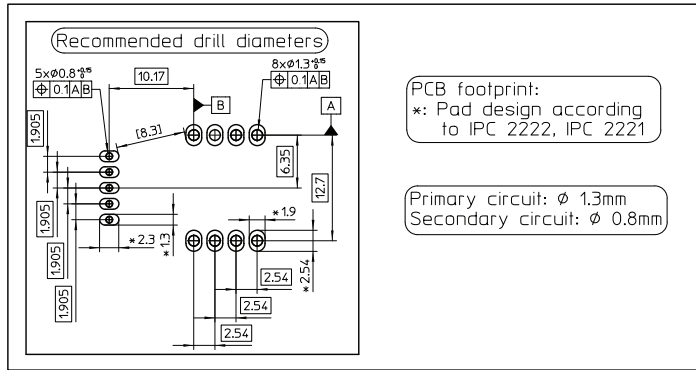

### Assembly on PCB

- Recommended PCB hole diameter 1.3 mm for primary pin  
0.8 mm for secondary pin
- Maximum PCB thickness 2.4 mm
- Wave soldering profile maximum 260 °C for 10 s  
No clean process only.

### Safety

This transducer must be used in limited-energy secondary circuits according to IEC 61800-5-1.



This transducer must be used in electric/electronic equipment with respect to applicable standards and safety requirements in accordance with the manufacturer's operating instructions.



Caution, risk of electrical shock

When operating the transducer, certain parts of the module can carry hazardous voltage (e.g. primary busbar, power supply). Ignoring this warning can lead to injury and/or cause serious damage. This transducer is a build-in device, whose conducting parts must be inaccessible after installation. A protective housing or additional shield could be used. Main supply must be able to be disconnected.

Dimensions (in mm)

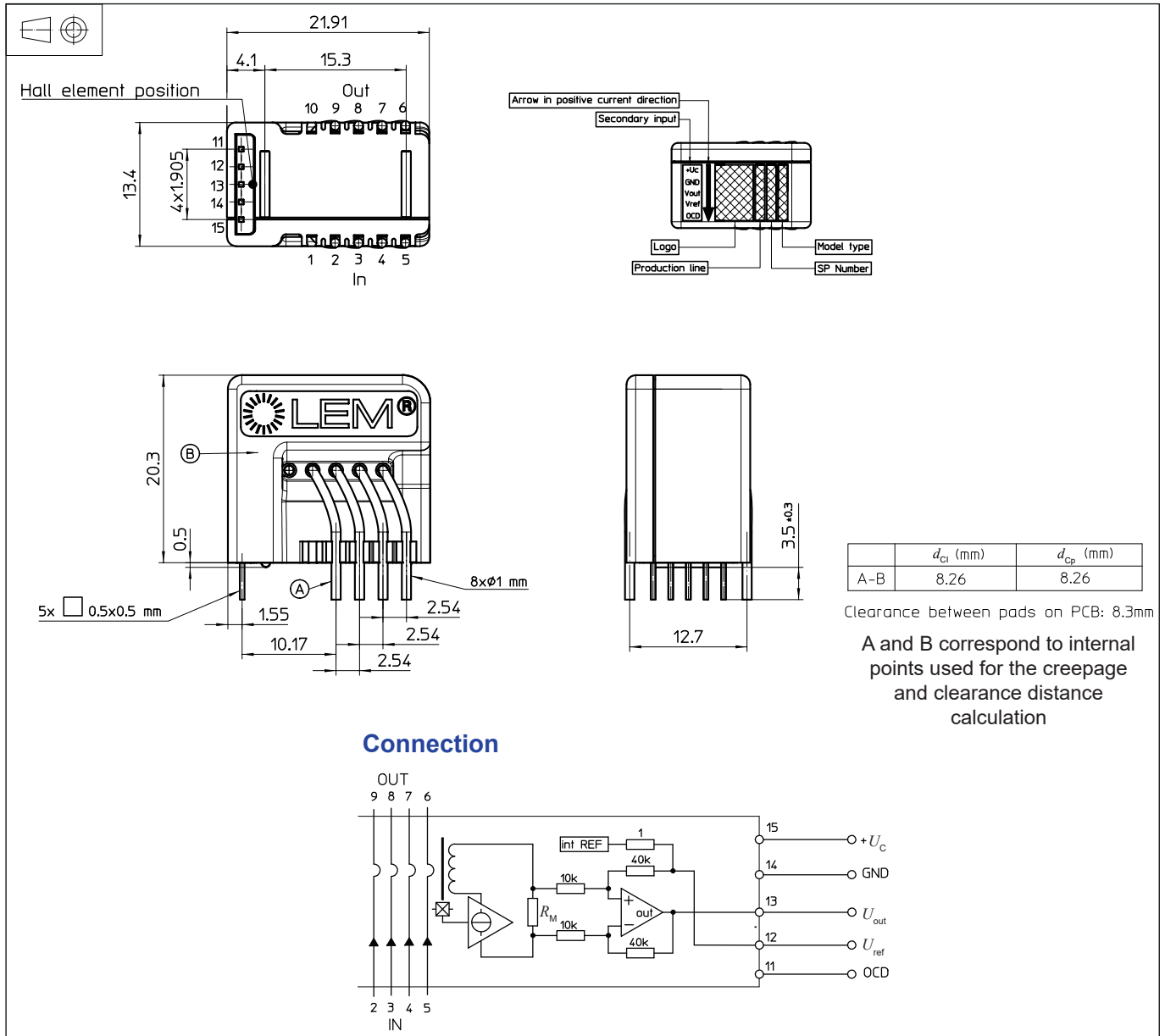

Mechanical characteristic

- General tolerance ±0.25 mm.

Remark

Installation of the transducer must be done, unless otherwise specified on the datasheet, according to LEM Transducer Generic Mounting Rules. Please refer to LEM document N°ANE120504 available on our Web site: <https://www.lem.com/en/file/3137/download/>.

## Packaging information

Standard delivery in cardboard: L × W × H: 315 × 200 × 120 mm

Each cardboard contains 200 parts, placed into 4 Polystyrene-made trays of 50 parts each one.

Both trays and cardboard are ESD-compliant.

The typical weight of the cardboard is 2.5 Kg.

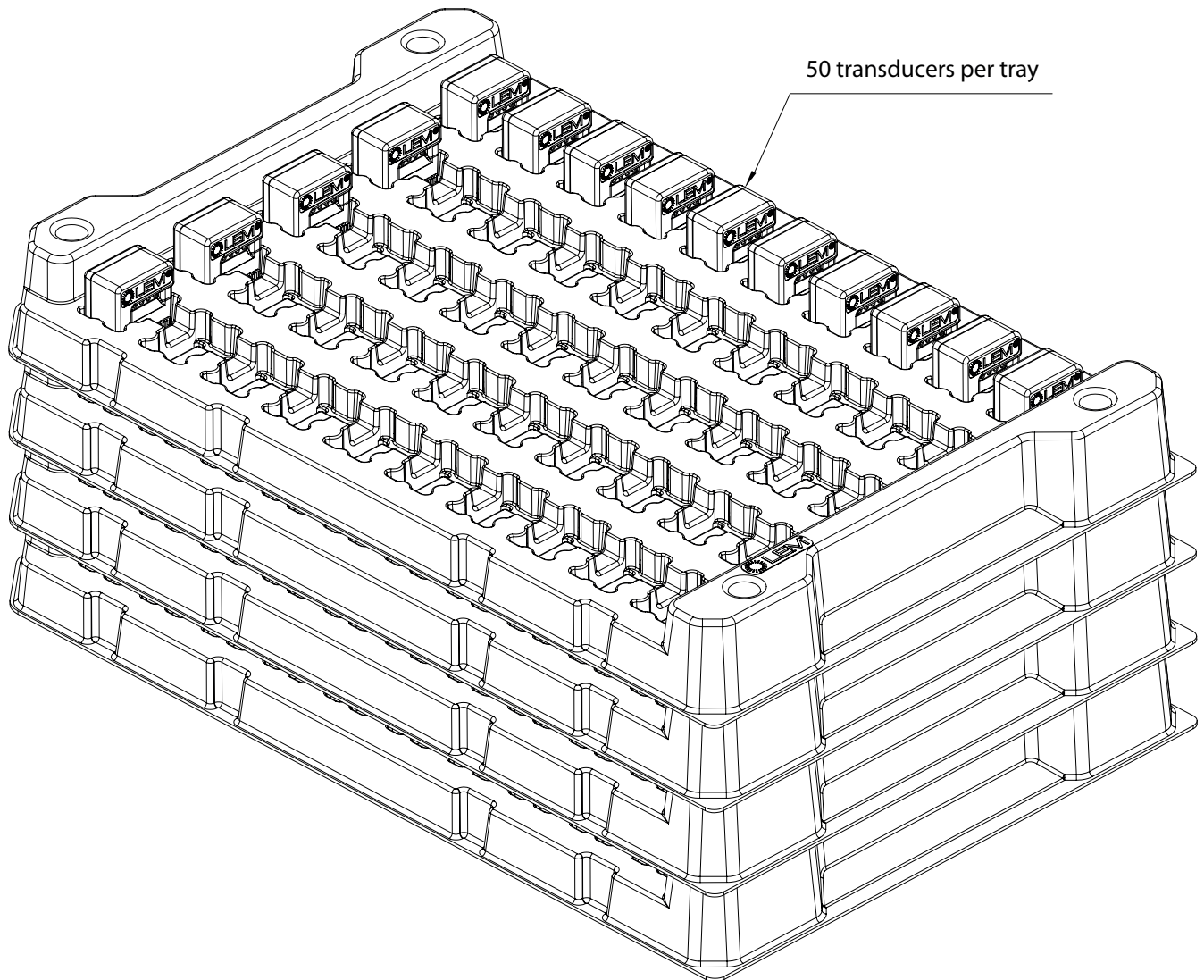

50 transducers per tray