

Current Transducer HOB-P/SP34 series

$I_{PN} = 50 \dots 130 \text{ A}$

Ref: HOB 50-P/SP34, HOB 75-P/SP34, HOB 100-P/SP34, HOB 130-P/SP34

For the electronic measurement of current: DC, AC, pulsed..., with galvanic separation between the primary and the secondary circuit.

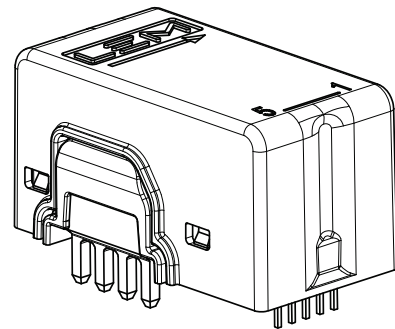

Features

- Open loop multi-range current transducer
- Voltage output
- Single power supply +3.3 V
- Galvanic separation between primary and secondary circuit
- Low power consumption
- Compact design for THT PCB mounting
- Factory calibrated.

Special feature

- Level shifting.

Advantages

- Low offset temperature drift
- Creepage / clearance > 11 mm
- Very short delay time < 200 ns
- High cut-off frequency > 1 MHz
- Enhanced immunity.

Applications

- AC variable speed and servo motor drives
- Static converters for DC motor drives
- Battery supplied applications
- Uninterruptible Power Supplies (UPS)
- Switched Mode Power Supplies (SMPS)
- Combiner box
- Solar inverter on DC side of the inverter (MPPT)
- Plasma cutter, welding
- Charging station.

Standards

- IEC 61010-1: 2017
- IEC 61010-2-30: 2017
- IEC 61800-3: 2017
- IEC 61800-5-1: 2007
- IEC 62109-1: 2010
- UL 508: 2018.

Application Domain

- Industrial.

Safety



Caution

If the device is used in a way that is not specified by the manufacturer, the protection provided by the device may be compromised. Always inspect the electronics unit and connecting cable before using this product and do not use it if damaged. Mounting assembly shall guarantee the maximum primary conductor temperature, fulfill clearance and creepage distance, minimize electric and magnetic coupling, and unless otherwise specified can be mounted in any orientation. This device is not intended for outdoor use.



Caution, risk of electrical shock

This transducer must be used in limited-energy secondary circuits SELV according to IEC 61010-1, in electric/electronic equipment with respect to applicable standards and safety requirements in accordance with the manufacturer's operating specifications.

Use caution during installation and use of this product; certain parts of the module can carry hazardous voltages and high currents (e.g. power supply, primary conductor).

Ignoring this warning can lead to injury and/or cause serious damage.

De-energize all circuits and hazardous live parts before installing the product.

All installations, maintenance, servicing operations and use must be carried out by trained and qualified personnel practicing applicable safety precautions.

This transducer is a build-in device, whose hazardous live parts must be inaccessible after installation.

This transducer must be mounted in a suitable end-enclosure.

Besides make sure to have a distance of minimum 30 mm between the primary terminals of the transducer and other neighboring components.

Main supply must be able to be disconnected.

Never connect or disconnect the external power supply while the primary circuit is connected to live parts.

Never connect the output to any equipment with a common mode voltage to earth greater than 30 V.

Always wear protective clothing and gloves if hazardous live parts are present in the installation where the measurement is carried out.

This transducer is a built-in device, not intended to be cleaned with any product. Nevertheless if the user must implement cleaning or washing process, validation of the cleaning program has to be done by himself.

When defining soldering process, please use no cleaning process only.



ESD susceptibility

The product is susceptible to be damaged from an ESD event and the personnel should be grounded when handling it.

Do not dispose of this product as unsorted municipal waste. Contact a qualified recycler for disposal.

Although LEM applies utmost care to facilitate compliance of end products with applicable regulations during LEM product design, use of this part may need additional measures on the application side for compliance with regulations regarding EMC and protection against electric shock. Therefore LEM cannot be held liable for any potential hazards, damages, injuries or loss of life resulting from the use of this product.



Direct current power supply.



Underwriters Laboratory Inc. recognized component

Absolute maximum ratings

Parameter	Symbol	Unit	Value
Supply voltage (not destructive)	U_C	V	5.5
Primary conductor temperature	T_B	°C	120
Electrostatic discharge voltage (HBM - Human Body Model)	U_{ESD}	kV	2

Stresses above these ratings may cause permanent damage. Exposure to absolute maximum ratings for extended periods may degrade reliability.

UL 508: Ratings and assumptions of certification

File # E189713 Volume: 2 Section: 19

Standards

- CSA C22.2 NO. 14-18 INDUSTRIAL CONTROL EQUIPMENT - Edition 13
- UL 508 STANDARD FOR INDUSTRIAL CONTROL EQUIPMENT - Edition 18

Ratings

Parameter	Symbol	Unit	Value
Primary involved potential		V AC/DC	600
Max surrounding air temperature	T_A	°C	100 105
Primary current	I_P	A	130 100
Secondary supply voltage	U_C	V DC	5
Output voltage	U_{out}	V	0 to 5
Current consumption (max)	I_C	mA	26

Conditions of acceptability

When installed in the end-use equipment, consideration shall be given to the following:

- 1 - The secondary circuit pin terminals have not been evaluated for field wiring.
- 2 - Low voltage control circuit shall be supplied by an isolating 5 V DC source.
- 3 - This product is intended to be mounted on a printed wiring board.

Marking

Only those products bearing the UR Mark should be considered to be Listed or Recognized and covered under UL's Follow-Up Service. Always look for the Mark on the product.

Insulation coordination

Parameter	Symbol	Unit	Value	Comment
RMS voltage for AC insulation test 50/60 Hz/1 min	U_d	kV	4.4	
Impulse withstand voltage 1.2/50 μ s	U_{Ni}	kV	9.6	
Partial discharge test voltage ($q_m < 10$ pC)	U_t	V	1500	Primary / Secondary
Clearance (pri. - sec.)	d_{Cl}	mm	> 11	Shortest distance through air
Creepage distance (pri. - sec.)	d_{Cp}	mm	> 11	Shortest path along device body
Clearance (pri. - sec.)		mm	> 11	When mounted on PCB with recommended layout
Case material				V0 according to UL 94
Comparative tracking index	CTI		600	
Application example		V	600	Reinforced insulation, non uniform field according to IEC 61800-5-1, CAT III PD2
Application example		V	1000	Basic insulation non uniform field according to IEC 61800-5-1, CAT III PD2
Application example		V	600	Simple insulation, non uniform field according to UL 508, CAT III PD2

Environmental and mechanical characteristics

Parameter	Symbol	Unit	Min	Typ	Max	Comment
Ambient operating temperature	T_A	$^{\circ}$ C	-40		105	
Ambient storage temperature	$T_{A\text{st}}$	$^{\circ}$ C	-40		105	
Mass	m	g		30		
Relative Humidity	RH	%			95	
Altitude		m			2000 ¹⁾	

Note:¹⁾ Insulation coordination at 2000 m.

Electrical data HOB 50-P/SP34

 At $T_A = 25\text{ °C}$, $U_C = +3.3\text{ V}$, $R_L = 10\text{ k}\Omega$ unless otherwise noted (see Min, Max, typ. definition paragraph in [page 9](#)).

Parameter	Symbol	Unit	Min	Typ	Max	Comment
Primary nominal RMS current	I_{PN}	A		50		
Primary current, measuring range	I_{PM}	A	-125		125	See Level shifting conditions on page 10
Number of primary turns	N_P			1		
Primary jumper resistance @ +25 °C	R_P	m Ω		0.06		
Primary jumper resistance @ +120 °C	R_P	m Ω		0.076		
Supply voltage	U_C	V	3.14	3.3	3.46	
Current consumption	I_C	mA	16	20	24	
Reference voltage (output)	U_{ref}	V	1.63	1.65	1.67	Internal reference
Reference voltage (input range)	U_{ref}	V	0.4		$U_C - 0.4$	External reference $U_{ref}(IN)$
Output voltage range @ I_{PM}	$U_{out} - U_{ref}$	V	-2.3		2.3	Over operating temperature range
U_{ref} output resistance	R_{ref}	Ω	130	200	300	Series
U_{out} output resistance	R_{out}	Ω		30		Series
Electrical offset voltage @ $I_P = 0\text{ A}$	U_{OE}	mV	-10		10	$U_{out} - U_{ref}$
Electrical offset current, referred to primary	I_{OE}	A	-0.543		0.543	
Temperature coefficient of U_{ref}	TCU_{ref}	ppm/K	-170		170	-40 °C ... 105 °C
Temperature coefficient of U_{OE}	TCU_{OE}	mV/K	-0.15		0.15	-40 °C ... 105 °C
Offset drift referred to primary @ $I_P = 0\text{ A}$	TCI_{OE}	mA/K	-8.152		8.152	-40 °C ... 105 °C
Nominal sensitivity	S_N	mV/A		18.4		920 mV @ I_{PN}
Sensitivity error @ I_{PN}	ε_S	%	-0.75		0.75	Factory adjustment
Temperature coefficient of S	TCS	ppm/K	-200		200	-40 °C ... 105 °C
Linearity error 0 ... I_{PN}	ε_L	% of I_{PN}	-0.70		0.70	
Linearity error 0 ... I_{PM}	ε_L	% of I_{PM}	-0.55		0.55	
Magnetic offset current (@ $10 \times I_{PN}$) referred to primary	I_{OM}	A	-0.8		0.8	One turn
Delay time to 10 % of the final output value for I_{PN} step	t_{D10}	ns			200	@ 100 A/ μ s
Delay time to 90 % of the final output value for I_{PN} step	t_{D90}	ns			200	@ 100 A/ μ s
Frequency bandwidth (-3 dB)	BW	kHz		1000		
RMS Noise voltage spectral density (Output) (100 Hz ... 10 kHz) (10 kHz ... 1 MHz)	u_{no}	$\mu\text{V}/\sqrt{\text{Hz}}$			20 1	
Peak-to-peak noise voltage (DC ... 10 kHz) (DC ... 100 kHz) (DC ... 1 MHz)	$U_{no pp}$	mV		1.8 1.9 1.9		
Sum of sensitivity and linearity error @ I_{PN}	ε_{SL}	% of I_{PN}	-1.45		1.45	
Sum of sensitivity and linearity error @ I_{PN} , @ $T_A = +85\text{ °C}$	ε_{SL85}	% of I_{PN}	-3.63		3.63	See formula note ¹⁾
Sum of sensitivity and linearity error @ I_{PN} , @ $T_A = +105\text{ °C}$	ε_{SL105}	% of I_{PN}	-4.35		4.35	See formula note ¹⁾

Note: ¹⁾ $\varepsilon_{SL}(T_A) = \varepsilon_{SL25} + \left(TCS + \frac{TCI_{OE}}{I_{PN}} \right) \times |T_A - 25|$ (Apply SI units and Quantity Calculus)

Electrical data HOB 75-P/SP34

At $T_A = 25\text{ °C}$, $U_C = +3.3\text{ V}$, $R_L = 10\text{ k}\Omega$ unless otherwise noted (see Min, Max, typ. definition paragraph in [page 9](#)).

Parameter	Symbol	Unit	Min	Typ	Max	Comment
Primary nominal RMS current	I_{PN}	A		75		
Primary current, measuring range	I_{PM}	A	-187.5		187.50	See Level shifting conditions on page 10
Number of primary turns	N_P			1		
Primary jumper resistance @ +25 °C	R_P	m Ω		0.06		
Primary jumper resistance @ +120 °C	R_P	m Ω		0.076		
Supply voltage	U_C	V	3.14	3.3	3.46	
Current consumption	I_C	mA	16	20	24	
Reference voltage (output)	U_{ref}	V	1.63	1.65	1.67	Internal reference
Reference voltage (input range)	U_{ref}	V	0.4		$U_C - 0.4$	External reference U_{ref} (IN)
Output voltage range @ I_{PM}	$U_{out} - U_{ref}$	V	-2.3		2.3	Over operating temperature range
U_{ref} output resistance	R_{ref}	Ω	130	200	300	Series
U_{out} output resistance	R_{out}	Ω		30		Series
Electrical offset voltage @ $I_P = 0\text{ A}$	U_{OE}	mV	-10		10	$U_{out} - U_{ref}$
Electrical offset current, referred to primary	I_{OE}	A	-0.815		0.815	
Temperature coefficient of U_{ref}	TCU_{ref}	ppm/K	-170		170	-40 °C ... 105 °C
Temperature coefficient of U_{OE}	TCU_{OE}	mV/K	-0.15		0.15	-40 °C ... 105 °C
Offset drift referred to primary @ $I_P = 0\text{ A}$	TCI_{OE}	mA/K	-12.228		12.228	-40 °C ... 105 °C
Nominal sensitivity	S_N	mV/A		12.267		920 mV @ I_{PN}
Sensitivity error @ I_{PN}	ϵ_S	%	-0.75		0.75	Factory adjustment
Temperature coefficient of S	TCS	ppm/K	-200		200	-40 °C ... 105 °C
Linearity error 0 ... I_{PN}	ϵ_L	% of I_{PN}	-0.60		0.60	
Linearity error 0 ... I_{PM}	ϵ_L	% of I_{PM}	-0.50		0.50	
Magnetic offset current (@ $10 \times I_{PN}$) referred to primary	I_{OM}	A	-0.8		0.8	One turn
Delay time to 10 % of the final output value for I_{PN} step	t_{D10}	ns			200	@ 100 A/ μ s
Delay time to 90 % of the final output value for I_{PN} step	t_{D90}	ns			200	@ 100 A/ μ s
Frequency bandwidth (-3 dB)	BW	kHz		1000		
RMS Noise voltage spectral density (Output) (100 Hz ... 10 kHz) (10 kHz ... 1 MHz)	u_{no}	$\mu\text{V}/\sqrt{\text{Hz}}$			20 1	
Peak-to-peak noise voltage (DC ... 10 kHz) (DC ... 100 kHz) (DC ... 1 MHz)	$U_{no\ pp}$	mV		1.2 1.3 1.4		
Sum of sensitivity and linearity error @ I_{PN}	ϵ_{SL}	% of I_{PN}	-1.35		1.35	
Sum of sensitivity and linearity error @ I_{PN} , @ $T_A = +85\text{ °C}$	ϵ_{SL85}	% of I_{PN}	-3.53		3.53	See formula note ¹⁾
Sum of sensitivity and linearity error @ I_{PN} , @ $T_A = +105\text{ °C}$	ϵ_{SL105}	% of I_{PN}	-4.25		4.25	See formula note ¹⁾

Note: ¹⁾ $\epsilon_{SL}(T_A) = \epsilon_{SL25} + \left(TCS + \frac{TCI_{OE}}{I_{PN}} \right) \times |T_A - 25|$ (Apply SI units and Quantity Calculus)

Electrical data HOB 100-P/SP34

 At $T_A = 25\text{ °C}$, $U_C = +3.3\text{ V}$, $R_L = 10\text{ k}\Omega$ unless otherwise noted (see Min, Max, typ. definition paragraph in [page 9](#)).

Parameter	Symbol	Unit	Min	Typ	Max	Comment
Primary nominal RMS current	I_{PN}	A		100		
Primary current, measuring range	I_{PM}	A	-250		250	See Level shifting conditions on page 10
Number of primary turns	N_P			1		
Primary jumper resistance @ +25 °C	R_P	m Ω		0.06		
Primary jumper resistance @ +120 °C	R_P	m Ω		0.076		
Supply voltage	U_C	V	3.14	3.3	3.46	
Current consumption	I_C	mA	16	20	24	
Reference voltage (output)	U_{ref}	V	1.63	1.65	1.67	Internal reference
Reference voltage (input range)	U_{ref}	V	0.4		$U_C - 0.4$	External reference U_{ref} (IN)
Output voltage range @ I_{PM}	$U_{out} - U_{ref}$	V	-2.3		2.3	Over operating temperature range
U_{ref} output resistance	R_{ref}	Ω	130	200	300	Series
U_{out} output resistance	R_{out}	Ω		30		Series
Electrical offset voltage @ $I_P = 0\text{ A}$	U_{OE}	mV	-10		10	$U_{out} - U_{ref}$
Electrical offset current, referred to primary	I_{OE}	A	-1.087		1.087	
Temperature coefficient of U_{ref}	TCU_{ref}	ppm/K	-170		170	-40 °C ... 105 °C
Temperature coefficient of U_{OE}	TCU_{OE}	mV/K	-0.15		0.15	-40 °C ... 105 °C
Offset drift referred to primary @ $I_P = 0\text{ A}$	TCI_{OE}	mA/K	-16.304		16.304	-40 °C ... 105 °C
Nominal sensitivity	S_N	mV/A		9.2		920 mV @ I_{PN}
Sensitivity error @ I_{PN}	ϵ_S	%	-0.75		0.75	Factory adjustment
Temperature coefficient of S	TCS	ppm/K	-200		200	-40 °C ... 105 °C
Linearity error 0 ... I_{PN}	ϵ_L	% of I_{PN}	-0.50		0.50	
Linearity error 0 ... I_{PM}	ϵ_L	% of I_{PM}	-0.40		0.40	
Magnetic offset current (@ $10 \times I_{PN}$) referred to primary	I_{OM}	A	-0.8		0.8	One turn
Delay time to 10 % of the final output value for I_{PN} step	t_{D10}	ns			200	@ 100 A/ μ s
Delay time to 90 % of the final output value for I_{PN} step	t_{D90}	ns			200	@ 100 A/ μ s
Frequency bandwidth (-3 dB)	BW	kHz		1000		
RMS Noise voltage spectral density (Output) (100 Hz ... 10 kHz) (10 kHz ... 1 MHz)	u_{no}	$\mu\text{V}/\sqrt{\text{Hz}}$			20 1	
Peak-to-peak noise voltage (DC ... 10 kHz) (DC ... 100 kHz) (DC ... 1 MHz)	$U_{no\text{pp}}$	mV		0.9 1 1.1		
Sum of sensitivity and linearity error @ I_{PN}	ϵ_{SL}	% of I_{PN}	-1.25		1.25	
Sum of sensitivity and linearity error @ I_{PN} , @ $T_A = +85\text{ °C}$	ϵ_{SL85}	% of I_{PN}	-3.43		3.43	See formula note ¹⁾
Sum of sensitivity and linearity error @ I_{PN} , @ $T_A = +105\text{ °C}$	ϵ_{SL105}	% of I_{PN}	-4.15		4.15	See formula note ¹⁾

Note: ¹⁾ $\epsilon_{SL}(T_A) = \epsilon_{SL25} + \left(TCS + \frac{TCI_{OE}}{I_{PN}} \right) \times |T_A - 25|$ (Apply SI units and Quantity Calculus)

Electrical data HOB 130-P/SP34

At $T_A = 25\text{ °C}$, $U_C = +3.3\text{ V}$, $R_L = 10\text{ k}\Omega$ unless otherwise noted (see Min, Max, typ. definition paragraph in [page 9](#)).

Parameter	Symbol	Unit	Min	Typ	Max	Comment
Primary nominal RMS current	I_{PN}	A		130		
Primary current, measuring range	I_{PM}	A	-250		250	See Level shifting conditions on page 10
Number of primary turns	N_p			1		
Primary jumper resistance @ +25 °C	R_p	m Ω		0.06		
Primary jumper resistance @ +120 °C	R_p	m Ω		0.076		
Supply voltage	U_C	V	3.14	3.3	3.46	
Current consumption	I_C	mA	16	20	24	
Reference voltage (output)	U_{ref}	V	1.63	1.65	1.67	Internal reference
Reference voltage (input range)	U_{ref}	V	0.4		$U_C - 0.4$	External reference U_{ref} (IN)
Output voltage range @ I_{PM}	$U_{out} - U_{ref}$	V	-2.3		2.3	Over operating temperature range
U_{ref} output resistance	R_{ref}	Ω	130	200	300	Series
U_{out} output resistance	R_{out}	Ω		30		Series
Electrical offset voltage @ $I_p = 0\text{ A}$	U_{OE}	mV	-10		10	$U_{out} - U_{ref}$
Electrical offset current, referred to primary	I_{OE}	A	-1.087		1.087	
Temperature coefficient of U_{ref}	TCU_{ref}	ppm/K	-170		170	-40 °C ... 105 °C
Temperature coefficient of U_{OE}	TCU_{OE}	mV/K	-0.15		0.15	-40 °C ... 105 °C
Offset drift referred to primary @ $I_p = 0\text{ A}$	TCI_{OE}	mA/K	-16.304		16.304	-40 °C ... 105 °C
Nominal sensitivity	S_N	mV/A		9.2		1196 mV @ I_{PN}
Sensitivity error @ I_{PN}	ε_S	%	-0.75		0.75	Factory adjustment
Temperature coefficient of S	TCS	ppm/K	-200		200	-40 °C ... 105 °C
Linearity error 0 ... I_{PN}	ε_L	% of I_{PN}	-0.45		0.45	
Linearity error 0 ... I_{PM}	ε_L	% of I_{PM}	-0.35		0.35	
Magnetic offset current (@ $10 \times I_{PN}$) referred to primary	I_{OM}	A	-0.8		0.8	One turn
Delay time to 10 % of the final output value for I_{PN} step	t_{D10}	ns			200	@ 100 A/ μ s
Delay time to 90 % of the final output value for I_{PN} step	t_{D90}	ns			200	@ 100 A/ μ s
Frequency bandwidth (-3 dB)	BW	kHz		1000		
RMS Noise voltage spectral density (Output) (100 Hz ... 10 kHz) (10 kHz ... 1 MHz)	u_{no}	$\mu\text{V}/\sqrt{\text{Hz}}$			20 1	
Peak-to-peak noise voltage (DC ... 10 kHz) (DC ... 100 kHz) (DC ... 1 MHz)	$U_{no pp}$	mV		0.9 1 1.1		
Sum of sensitivity and linearity error @ I_{PN}	ε_{SL}	% of I_{PN}	-1.20		1.20	
Sum of sensitivity and linearity error @ I_{PN} , @ $T_A = +85\text{ °C}$	ε_{SL85}	% of I_{PN}	-3.15		3.15	See formula note ¹⁾
Sum of sensitivity and linearity error @ I_{PN} , @ $T_A = +105\text{ °C}$	ε_{SL105}	% of I_{PN}	-3.80		3.80	See formula note ¹⁾

Note: ¹⁾ $\varepsilon_{SL}(T_A) = \varepsilon_{SL25} + \left(TCS + \frac{TCI_{OE}}{I_{PN}} \right) \times |T_A - 25|$ (Apply SI units and Quantity Calculus)

Definition of typical, minimum and maximum values

Minimum and maximum values for specified limiting and safety conditions have to be understood as such as well as values shown in “typical” graphs.

On the other hand, measured values are part of a statistical distribution that can be specified by an interval with upper and lower limits and a probability for measured values to lie within this interval.

Unless otherwise stated (e.g. “100 % tested”), the LEM definition for such intervals designated with “min” and “max” is that the probability for values of samples to lie in this interval is 99.73 %.

For a normal (Gaussian) distribution, this corresponds to an interval between -3 sigma and +3 sigma. If “typical” values are not obviously mean or average values, those values are defined to delimit intervals with a probability of 68.27 %, corresponding to an interval between -sigma and +sigma for a normal distribution.

Typical, maximal and minimal values are determined during the initial characterization of the product.

Maximum continuous DC current

For all ranges

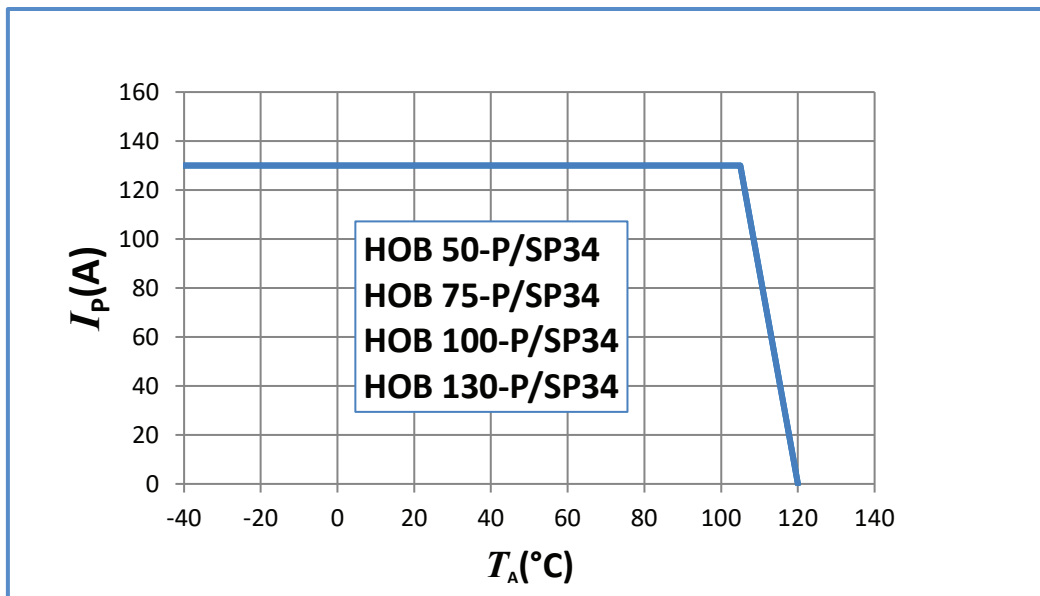

Important notice: whatever the usage and/or application, the transducer jumper temperature shall not go above the maximum rating of 120 °C as stated in page 3 of this datasheet.

Level shifting: measuring range versus external reference voltage U_{ref} (IN)

HOB 50-P/SP34

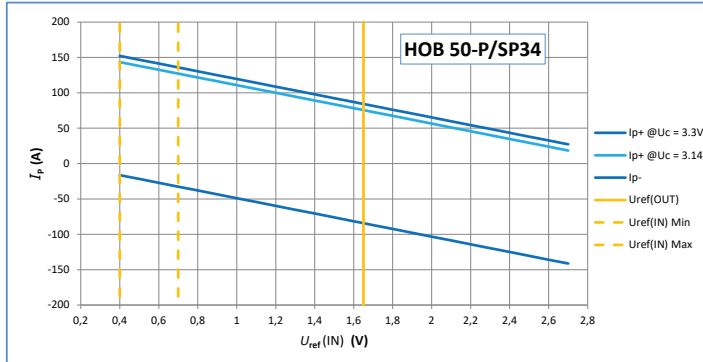

HOB 75-P/SP34

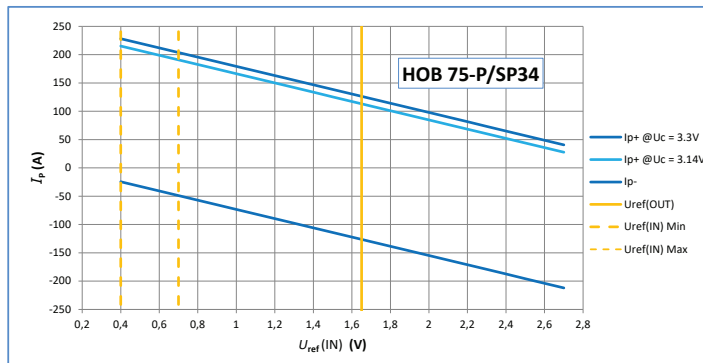

HOB 100-P/SP34

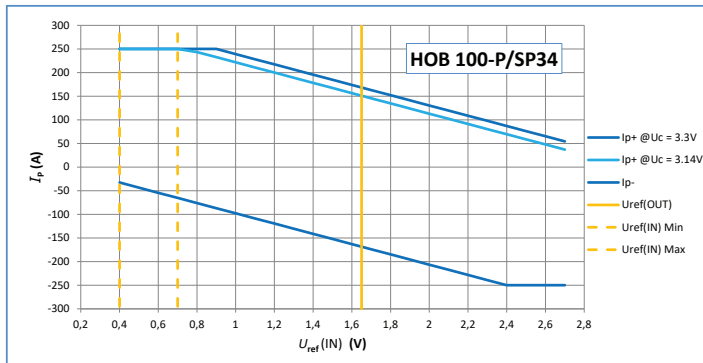

HOB 130-P/SP34

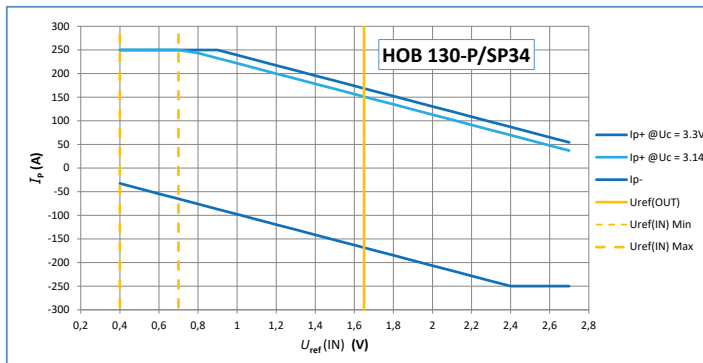

U_{ref} (IN) Min-Max defines the recommended interval in order to reach the $I_{P\ max}$ range (asymetrical and positive value only).

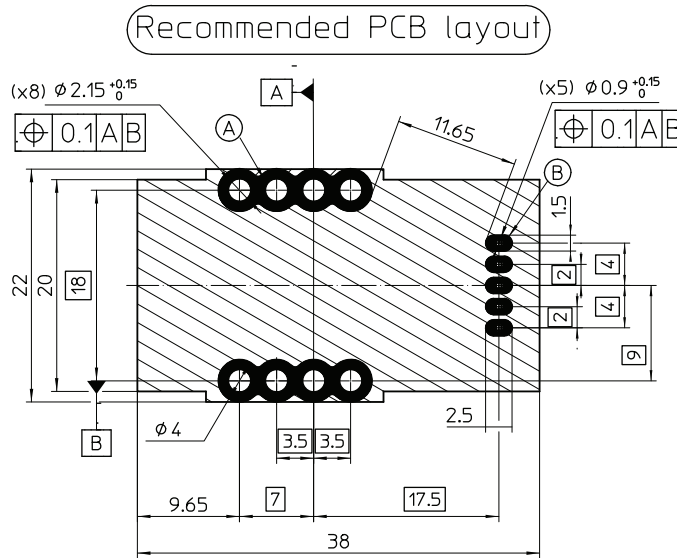
PCB Footprint (in mm, general tolerance ± 0.3 mm)

Pad design according to IPC2222, IPC2221

Assembly on PCB

- Recommended PCB hole diameter 2.15 mm for primary pin
0.9 mm for secondary pin
- Maximum PCB thickness 2.4 mm
- Wave soldering profile maximum 260 °C, 10 s
No clean process only

Insulation distance (nominal values):

	d_{CP}	d_{CI}
On PCB: A - B	11.65 mm	-
Between jumper and secondary block	13.75 mm	11.49 mm

Remark

Installation of the transducer must be done unless otherwise specified on the datasheet, according to LEM Transducer Generic Mounting Rules. Please refer to LEM document N°ANE120504 available on our Web site: <https://www.lem.com/en/file/3137/download/>.

Dimensions (in mm, general tolerance ± 0.3 mm)

