

Voltage transducer DVL 1500/SP1

$U_{PN} = 1500\text{ V}$

For the electronic measurement of voltage: DC, AC, pulsed..., with galvanic separation between the primary and the secondary circuit.

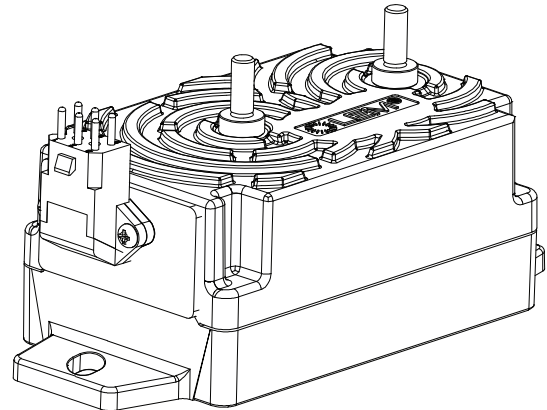

Features

- Bipolar and insulated measurement up to 2250 V
- Current output
- Primary input connection with M5 studs
- Compatible with AV 100 family.

Special features

- SMS6GE6 Burndy connector is used for secondary connection
- Customer marking: DTR0000334135.

Advantages

- Low consumption and low losses
- Compact design
- Good behavior under common mode variations
- Excellent accuracy (offset, sensitivity, linearity)
- Good delay time
- Low temperature variation
- High immunity to external interferences.

Applications

- AC variable speed and servo motor drives
- Static converters for DC motor drives
- Battery supplied applications
- Uninterruptible Power Supplies (UPS)
- Switched Mode Power Supplies (SMPS)
- Power supplies for welding applications
- Renewable Energy (Solar and Wind)
- Single or three phase inverters
- Propulsion and braking choppers
- Propulsion converters
- Auxiliary converters
- High power drives
- Substations.

Standards

- EN 50155: 2021
- EN 50178: 1997
- EN 50124-1: 2017
- EN 50121-3-2: 2016
- UL 508: 2013
- IEC 61010-1:2010/AMD1: 2016.

Application Domains

- Railway (fixed installations and onboard)
- Industrial.

Absolute maximum ratings

| Parameter | Symbol | Unit | Value |
|---|-------------------------|------|--|
| Maximum supply voltage ($U_p = 0 \text{ V}$, 0.1 s) | $\pm U_{C \text{ max}}$ | V | ± 34 |
| Maximum supply voltage (working) (-40 ... 85 °C) | $\pm U_{C \text{ max}}$ | V | ± 26.4 |
| Maximum primary voltage (-40 ... 85 °C) | $U_{P \text{ max}}$ | V | 2250 |
| Maximum steady state primary voltage (-40 ... 85 °C) | $U_{P \text{ N max}}$ | V | 1500 see derating on figure 2 |

Absolute maximum ratings apply at 25 °C unless otherwise noted.
 Stresses above these ratings may cause permanent damage.
 Exposure to absolute maximum ratings for extended periods may degrade reliability.

UL 508: Ratings and assumptions of certification

File # E189713 Volume: 2 Section: 7

Standards

- USR indicated investigation to the Standard for Industrial Control Equipment UL 508.
- CNR Indicated investigation to the Canadian standard for Industrial Control Equipment CSA C22.2 No. 14-13

Conditions of acceptability

When installed in the end-use equipment, consideration shall be given to the following:

- 1 - *These devices must be mounted in a suitable end-use enclosure.*
- 2 - *The terminal have not been evaluated for field wiring.*
- 3 - *Low voltage circuits are intended to be powered by a circuit derived from an isolating source (such as transformer, optical isolator, limiting impedance or electro-mechanical relay) and having no direct connection back to the primary circuit (other than through the grounding means).*

Marking

Only those products bearing the UL or UR Mark should be considered to be Listed or Recognized and covered under UL's Follow-Up Service. Always look for the Mark on the product.

Insulation coordination

| Parameter | Symbol | Unit | Value | Comment |
|---|--|------------|--|---------------------------------|
| RMS voltage for AC insulation test, 50 Hz, 1 min | U_d | kV | 8.5 | 100 % tested in production |
| Impulse withstand voltage 1.2/50 μ s | U_{Ni} | kV | 16 | |
| Partial discharge RMS test voltage ($q_m < 10$ pC) | U_t | V | 2700 | |
| Insulation resistance | R_{INS} | M Ω | 200 | measured at 500 V DC |
| Clearance (pri. - sec.) | d_{Cl} | mm | See dimensions drawing on page 9 | Shortest distance through air |
| Creepage distance (pri. - sec.) | d_{Cp} | mm | | Shortest path along device body |
| Case material | - | - | V0 | According to UL 94 |
| Comparative tracking index | CTI | | 600 | |
| Maximum DC common mode voltage | $U_{HV+} + U_{HV-}$ and $ U_{HV+} - U_{HV-} $ | kV | ≤ 4.2 $\leq U_{PM}$ | |

Environmental and mechanical characteristics

| Parameter | Symbol | Unit | Min | Typ | Max |
|--|------------------|--------------|-----|-----|---------------|
| Ambient operating temperature | T_A | $^{\circ}$ C | -40 | | 85 |
| Ambient storage temperature | $T_{A\text{st}}$ | $^{\circ}$ C | -50 | | 90 |
| Equipment operating temperature class | | | | | EN 50155: OT6 |
| Switch-on extended operating temperature class | | | | | EN 50155: ST0 |
| Rapid temperature variation class | | | | | EN 50155: H2 |
| Conformal coating type | | | | | EN 50155: PC2 |
| Mass | m | g | | 270 | |

RAMS data

| Parameter | Symbol | Unit | Min | Typ | Max |
|-------------------|-----------------|----------|-----|-----------|--|
| Useful life class | | | | | EN 50155: L4 |
| Mean failure rate | $\bar{\lambda}$ | h^{-1} | | 1/1835004 | According to IEC 62380: 2004 $T_A = 45$ $^{\circ}$ C ON: 20 hrs/day ON/OFF: 320 cycles/year $U_C = \pm 24$ V, $U_P = 1500$ V |

Electrical data

At $T_A = 25\text{ °C}$, $\pm U_C = \pm 24\text{ V}$, $R_M = 100\ \Omega$, unless otherwise noted.

Lines with a * in the conditions column apply over the $-40 \dots 85\text{ °C}$ ambient temperature range.

| Parameter | Symbol | Unit | Min | Typ | Max | Conditions |
|--|---------------------|-----------------|--------------|--------------|------------|--|
| Primary nominal RMS voltage | U_{PN} | V | | 1500 | | * |
| Primary voltage, measuring range | U_{PM} | V | -2250 | | 2250 | * |
| Measuring resistance | R_M | Ω | 0 | | 120 | * See derating on figure 2 . For $ U_{PM} < 2250\text{ V}$, max value of R_M is given on figure 1 |
| Secondary nominal RMS current | I_{SN} | mA | | 50 | | * |
| Secondary current | I_S | mA | -75 | | 75 | * |
| Supply voltage | $\pm U_C$ | V | ± 13.5 | ± 24 | ± 26.4 | * |
| Rise time of U_C (10-90 %) | t_{rise} | ms | | | 100 | |
| Current consumption @ $U_C = \pm 24\text{ V}$ at $U_p = 0\text{ V}$ | I_C | mA | | 20 | 25 | |
| Inrush current | | | | | | NA (EN 50155) |
| Interruptions on power supply voltage class | | | | | | NA (EN 50155) |
| Supply change-over class | | | | | | NA (EN 50155) |
| Offset current | I_O | μA | -50 | 0 | 50 | 100 % tested in production |
| Temperature variation of I_O | I_{OT} | μA | -120 -150 | | 120 150 | -25 ... 85 °C -40 ... 85 °C |
| Sensitivity | S | $\mu\text{A/V}$ | | 33.33 | | 50 mA for primary 1500 V |
| Sensitivity error | ε_S | % | -0.2 | 0 | 0.2 | |
| Temperature variation of sensitivity error | ε_{ST} | % | -0.5 | | 0.5 | * Referred to 25 °C |
| Linearity error | ε_L | % of U_{PM} | -0.5 | | 0.5 | * $\pm 1500\text{ V}$ range |
| Total error | ε_{tot} | % of U_{PN} | -0.5 -1 | | 0.5 1 | * 25 °C; 100 % tested in production -40 ... 85 °C |
| RMS noise current referred to primary | I_{no} | μA | | 10 | | 1 Hz to 100 kHz |
| Delay time @ 10 % of the final output value $U_{PN\text{step}}$ | t_{D10} | μs | | 30 | | |
| Delay time @ 90 % of the final output value $U_{PN\text{step}}$ | t_{D90} | μs | | 50 | 60 | 0 to 1500 V step, 6 kV/ μs |
| Frequency bandwidth | BW | kHz | | 14 8 2 | | -3 dB -1 dB -0.1 dB |
| Start-up time | t_{start} | ms | | 190 | 250 | * |
| Resistance of primary (winding) | R_p | M Ω | | 11.3 | | * |
| Total primary power loss @ U_{PN} | P_p | mW | | 0.2 | | * |

Definition of typical, minimum and maximum values

Minimum and maximum values for specified limiting and safety conditions have to be understood as such as well as values shown in "typical" graphs.

On the other hand, measured values are part of a statistical distribution that can be specified by an interval with upper and lower limits and a probability for measured values to lie within this interval.

Unless otherwise stated (e.g. "100 % tested"), the LEM definition for such intervals designated with "min" and "max" is that the probability for values of samples to lie in this interval is 99.73 %.

For a normal (Gaussian) distribution, this corresponds to an interval between -3 sigma and +3 sigma. If "typical" values are not obviously mean or average values, those values are defined to delimit intervals with a probability of 68.27 %, corresponding to an interval between -sigma and +sigma for a normal distribution.

Typical, maximal and minimal values are determined during the initial characterization of a product.

Typical performance characteristics

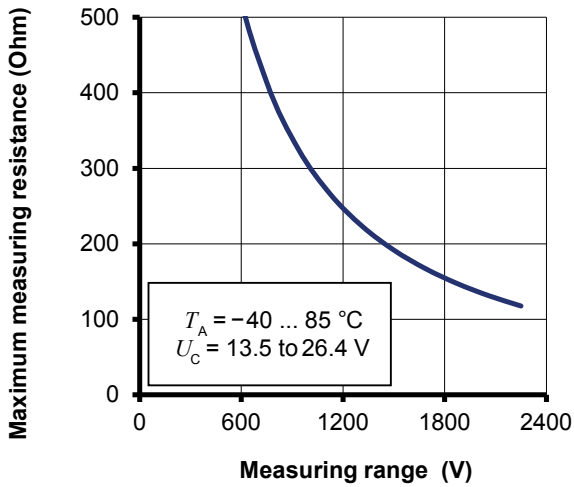

Figure 1: Maximum measuring resistance

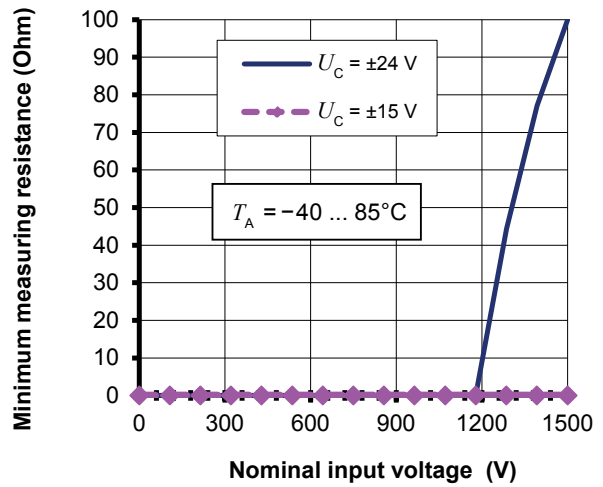

Figure 2: Minimum measuring resistance
For T_A under 80 °C, the minimum measuring resistance is 0 Ω whatever U_C

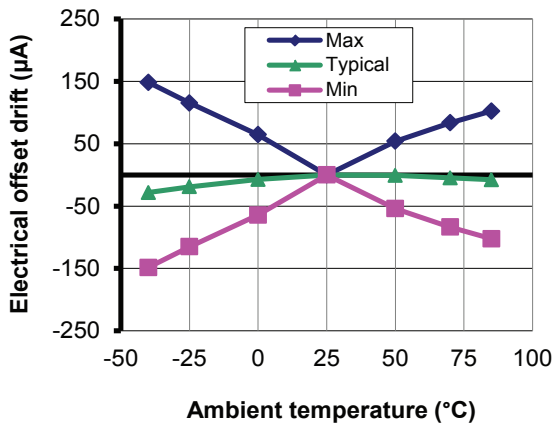

Figure 3: Electrical offset thermal drift

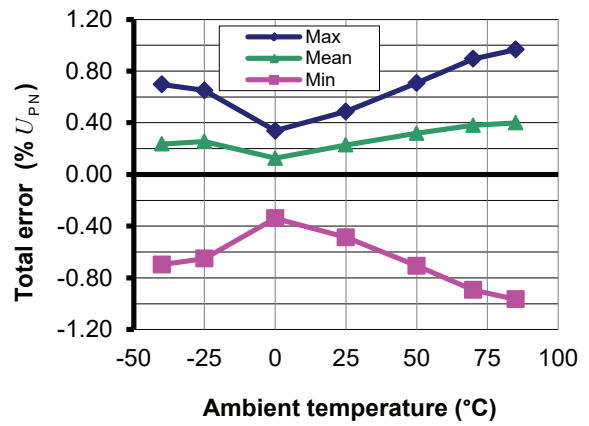

Figure 4: Total error in temperature

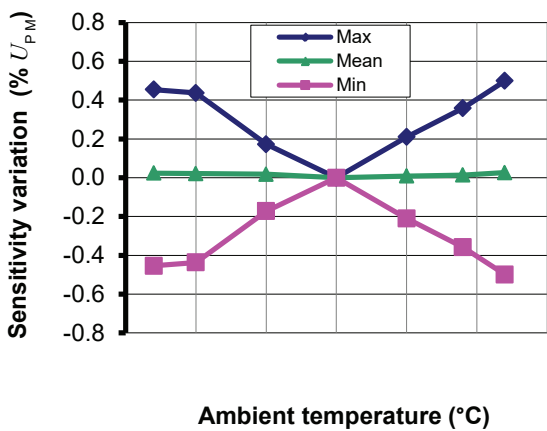

Figure 5: Sensitivity thermal variation

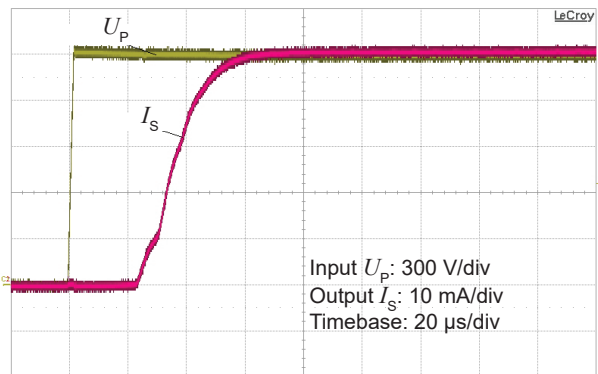

Figure 6: Typical step response (0 to 1500 V)

Typical performance characteristics continued

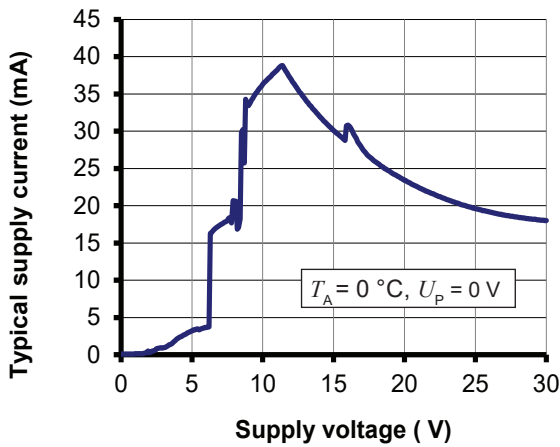

Figure 7: Supply current function of supply voltage

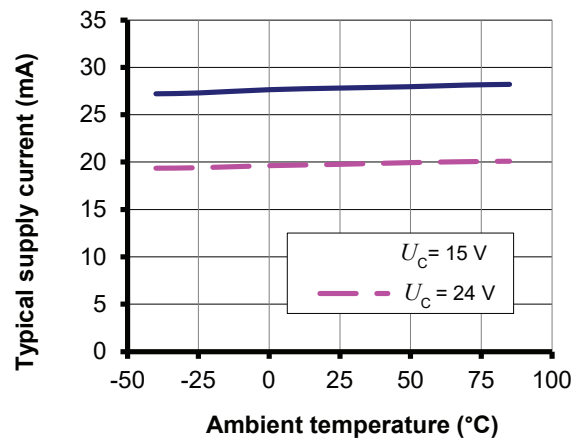
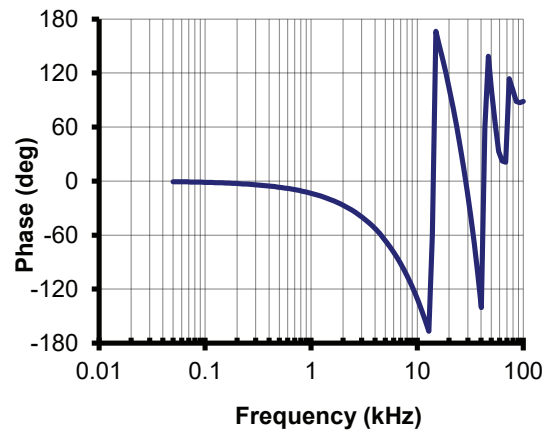
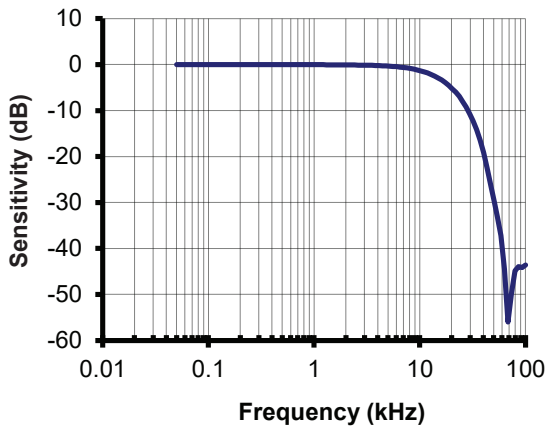
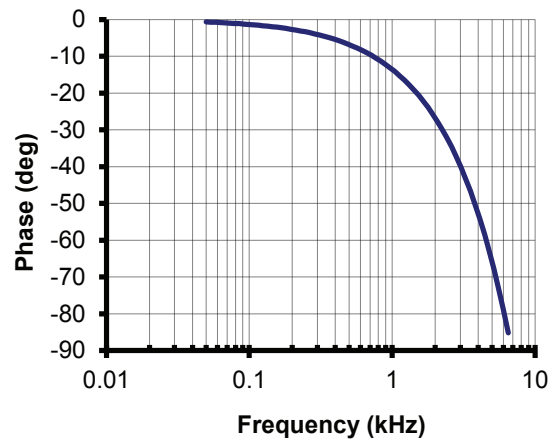
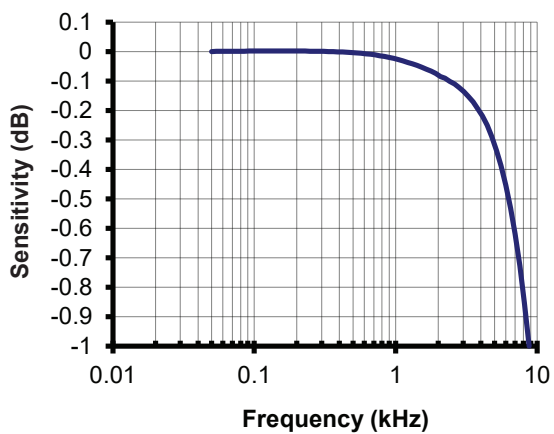

Figure 8: Supply current function of temperature



Figures 9 and 10: Typical frequency and phase response



Figures 11 and 12: Typical frequency and phase response (detail)

Typical performance characteristics continued

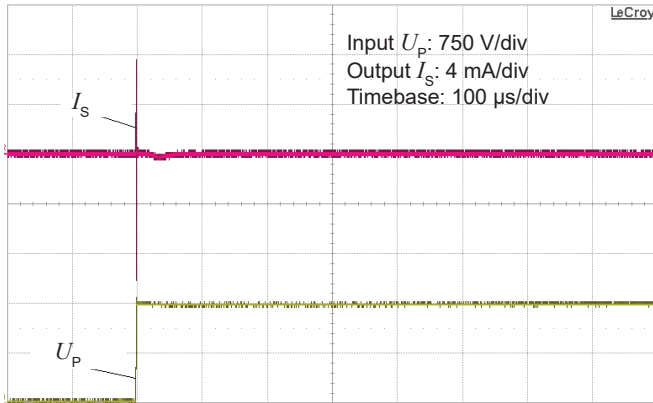

Figure 13: Typical common mode perturbation (1500 V step with 6 kV/μs $R_M = 100 \Omega$)

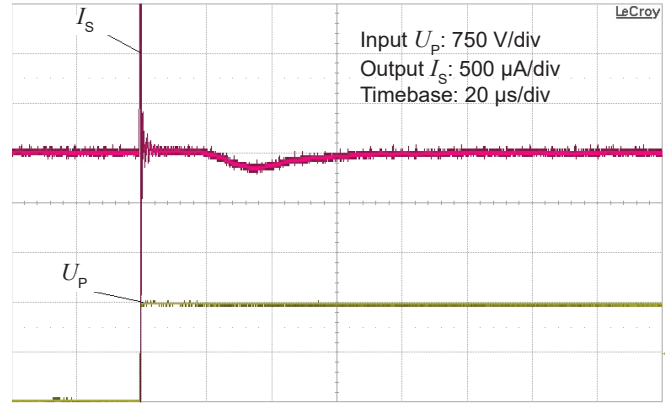

Figure 14: Detail of typical common mode perturbation (1500 V step with 6 kV/μs, $R_M = 100 \Omega$)

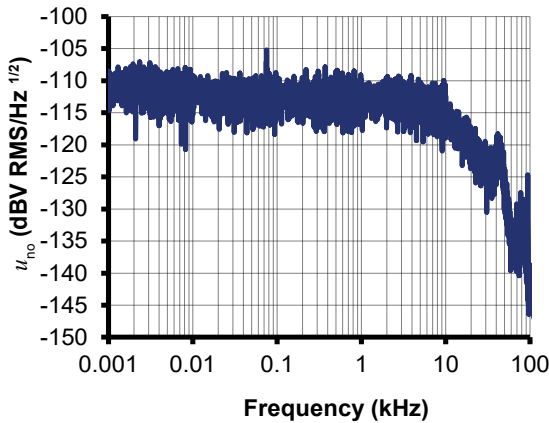

Figure 15: Typical noise voltage spectral density u_{no} with $R_M = 50 \Omega$

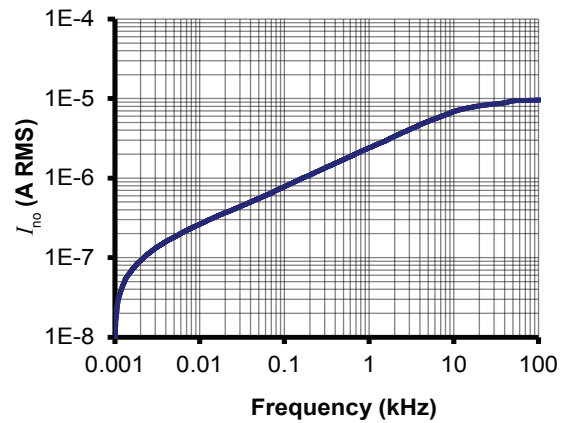

Figure 16: Typical total RMS noise current with $R_M = 50 \Omega$

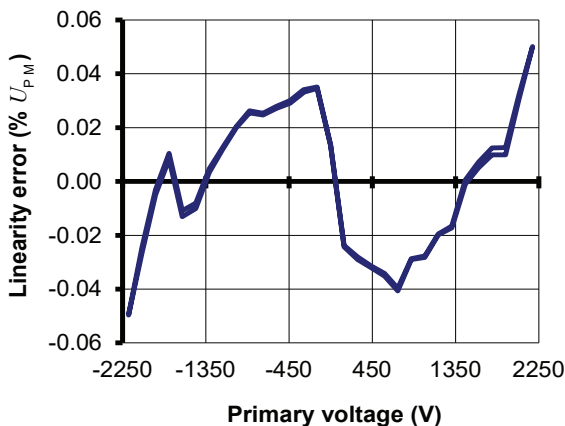

Figure 17: Typical linearity error at 25 °C

Figure 15 (noise voltage spectral density) shows that there are no significant discrete frequencies in the output. Figure 16 confirms the absence of steps in the total RMS noise current that would indicate discrete frequencies. To calculate the noise in a frequency band f_1 to f_2 , the formula is:

$$I_{no}(f_1 \text{ to } f_2) = \sqrt{I_{no}(f_2)^2 - I_{no}(f_1)^2}$$

with $I_{no}(f)$ read from figure 16 (typical, RMS value).

Example:

What is the noise from 10 to 100 Hz?

Figure 16 gives $I_{no}(10 \text{ Hz}) = 0.26 \mu\text{A}$ and

$I_{no}(100 \text{ Hz}) = 0.8 \mu\text{A}$.

The RMS noise current is therefore.

$$\sqrt{(0.8 \times 10^{-6})^2 - (0.26 \times 10^{-6})^2} = 0.76 \mu\text{A}$$

Performance parameters definition

The schematic used to measure all electrical parameters are:

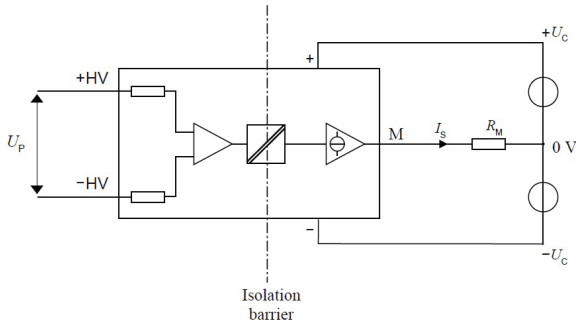

Figure 16: standard characterization schematics for current output transducers ($R_M = 50 \Omega$ unless otherwise noted)

Transducer simplified model

The static model of the transducer at temperature T_A is:

$$I_S = S \cdot U_P + \varepsilon$$

In which

$$\varepsilon = I_{OE} + I_{OT}(T_A) + \varepsilon_S \cdot S \cdot U_P + \varepsilon_{ST}(T_A) \cdot S \cdot U_P + \varepsilon_L \cdot S \cdot U_{PM}$$

- I_S : secondary current (A)
- S : sensitivity of the transducer ($\mu A/V$)
- U_P : primary voltage (V)
- U_{PM} : primary voltage, measuring range (V)
- T_A : ambient operating temperature ($^{\circ}C$)
- I_{OE} : electrical offset current (A)
- $I_{OT}(T_A)$: temperature variation of I_{OE} at temperature T_A (A)
- ε_S : sensitivity error at $25^{\circ}C$
- $\varepsilon_{ST}(T_A)$: temperature variation of sensitivity error at temperature T_A
- ε_L : linearity error

This is the absolute maximum error. As all errors are independent, a more realistic way to calculate the error would be to use the following formula:

$$\varepsilon = \sqrt{\sum_{i=1}^N \varepsilon_i^2}$$

Sensitivity and linearity

To measure sensitivity and linearity, the primary voltage (DC) is cycled from 0 to U_{PM} , then to $-U_{PM}$ and back to 0 (equally spaced $U_{PM}/10$ steps).

The sensitivity S is defined as the slope of the linear regression line for a cycle between $\pm U_{PM}$.

The linearity error ε_L is the maximum positive or negative difference between the measured points and the linear regression line, expressed in % of the maximum measured value.

Electrical offset

The electrical offset current I_{OE} is the residual output current when the input voltage is zero.

The temperature variation I_{OT} of the electrical offset current I_{OE} is the variation of the electrical offset from $25^{\circ}C$ to the considered temperature.

Total error

The total error ε_{tot} is the error at $\pm U_{PN}$, relative to the rated value U_{PN} .

It includes all errors mentioned above.

Delay times

The delay time t_{D10} and the delay time t_{D90} are shown in the next figure.

Both depend on the primary voltage dv/dt . They are measured at nominal voltage.

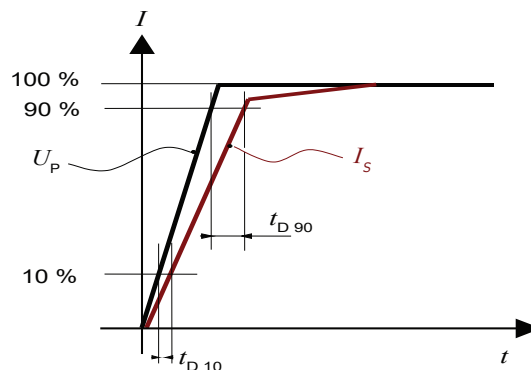
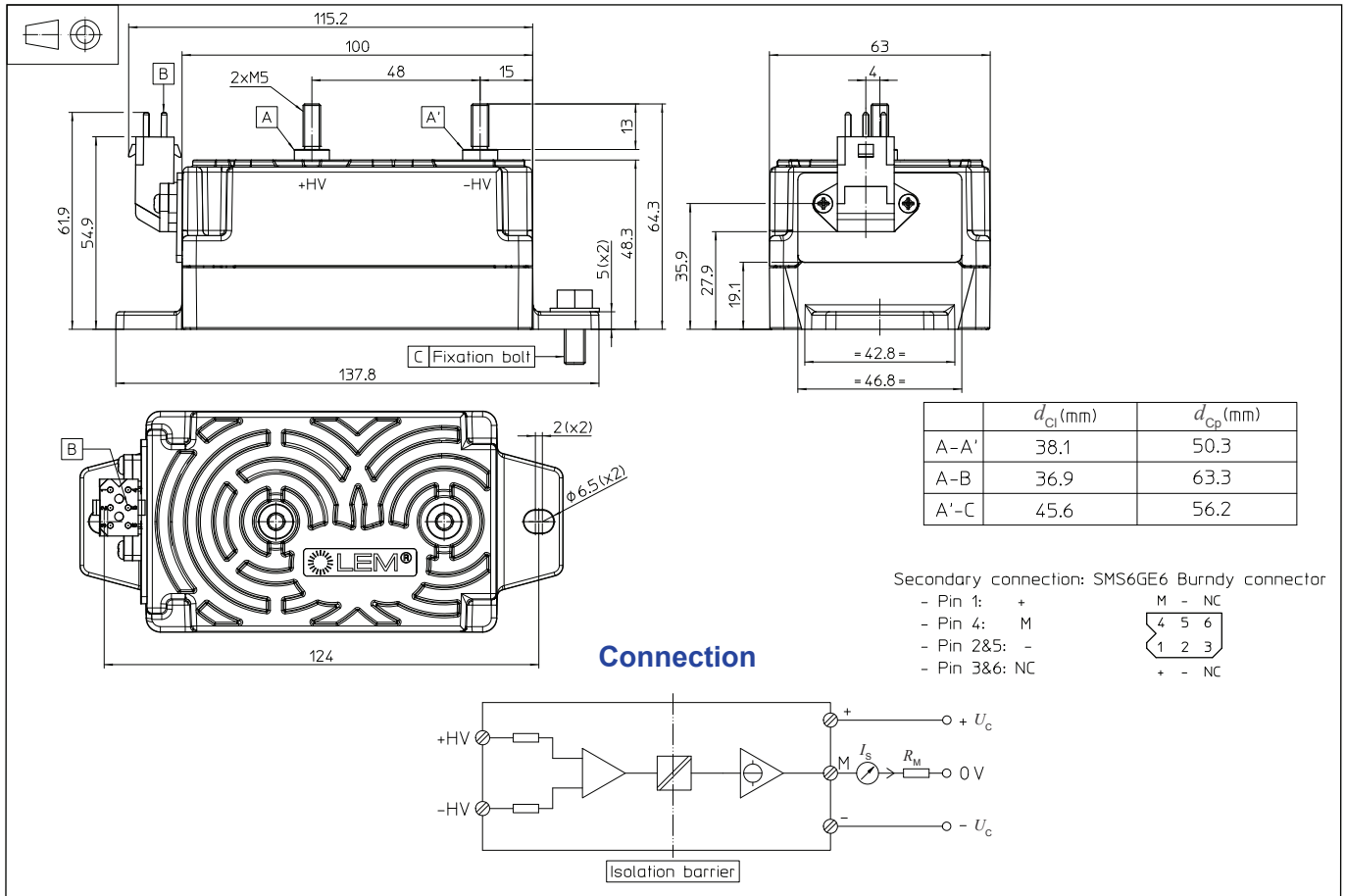

Figure 19: Delay time t_{D90} @ 90 and delay time t_{D10} @ 10

Dimensions (in mm)

Mechanical characteristics

- General tolerance ± 0.5 mm
- Transducer fastening
 - 2 holes $\varnothing 6.5$ mm
 - 2 M6 steel screws
 - Recommended fastening torque 4 N·m
- Connection of primary
 - 2 M5 threaded studs
 - Recommended fastening torque 2.2 N·m
- Connection of secondary
 - SMS6GE6 Burndy connector

Remarks

- I_s is positive when a positive voltage is applied on +HV.
- The transducer is directly connected to the primary voltage.
- The primary cables have to be routed together all the way.
- The secondary cables also have to be routed together all the way.
- Installation of the transducer is to be done without primary or secondary voltage present
- Installation of the transducer must be done unless otherwise specified on the datasheet, according to LEM Transducer Generic Mounting Rules. Please refer to LEM document N°ANE120504 available on our Web site: <https://www.lem.com/en/file/3137/download/>.

Safety

This transducer must be used in limited-energy secondary circuits according to IEC 61010-1.



This transducer must be used in electric/electronic equipment with respect to applicable standards and safety requirements in accordance with the manufacturer's operating instructions.



Caution, risk of electrical shock

When operating the transducer, certain parts of the module can carry hazardous voltage (e.g. primary connections, power supply). Ignoring this warning can lead to injury and/or cause serious damage. This transducer is a build-in device, whose conducting parts must be inaccessible after installation. A protective housing or additional shield could be used. Main supply must be able to be disconnected.

Note: Additional information available on request.