

AUTOMOTIVE CURRENT TRANSDUCER OPEN LOOP TECHNOLOGY

DHAB S/125



Introduction

The DHAB family is best suited for DC, AC, or pulsed currents measurement in high power and low voltage automotive applications. It features galvanic separation between the primary circuit (high power) and the secondary circuit (electronic circuit).

The DHAB family gives you a choice of having different current measuring ranges in the same housing (from ± 20 up to ± 900 A).

Features

- Open Loop transducer using the Hall effect
- Low voltage application
- Unipolar +5 V DC power supply
- Primary current measuring range up to ± 25 A for channel 1 and ± 200 A for channel 2
- Maximum RMS primary admissible current: defined by busbar to have $T^\circ < +150$ °C
- Operating temperature range: -40 °C $< T^\circ < +125$ °C
- Output voltage: full ratio-metric (in sensitivity and offset).

Special feature

- Dual channel sensor for wider measurement range and redundancy.

Advantages

- Good accuracy for high and low current range
- Good linearity
- Low thermal offset drift
- Low thermal sensitivity drift
- Hermetic package.

Automotive applications

- Battery Pack Monitoring
- Hybrid Vehicles
- EV and Utility Vehicles.

Principle of DHAB Family

The open loop transducers uses a Hall effect integrated circuit. The magnetic flux density B , contributing to the rise of the Hall voltage, is generated by the primary current I_p to be measured. The current to be measured I_p is supplied by a current source i.e. battery or generator (Figure 1).

Within the linear region of the hysteresis cycle, B is proportional to:

$$B(I_p) = \text{constant (a)} \times I_p$$

The Hall voltage is thus expressed by:

$$V_H = (R_H/d) \times I \times \text{constant (a)} \times I_p$$

Except for I_p , all terms of this equation are constant. Therefore:

$$V_H = \text{constant (b)} \times I_p$$

The measurement signal V_H amplified to supply the user output voltage or current.

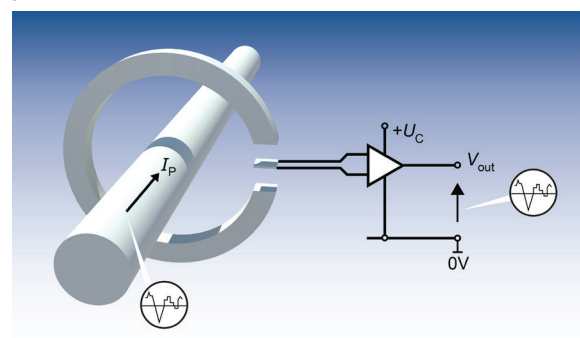
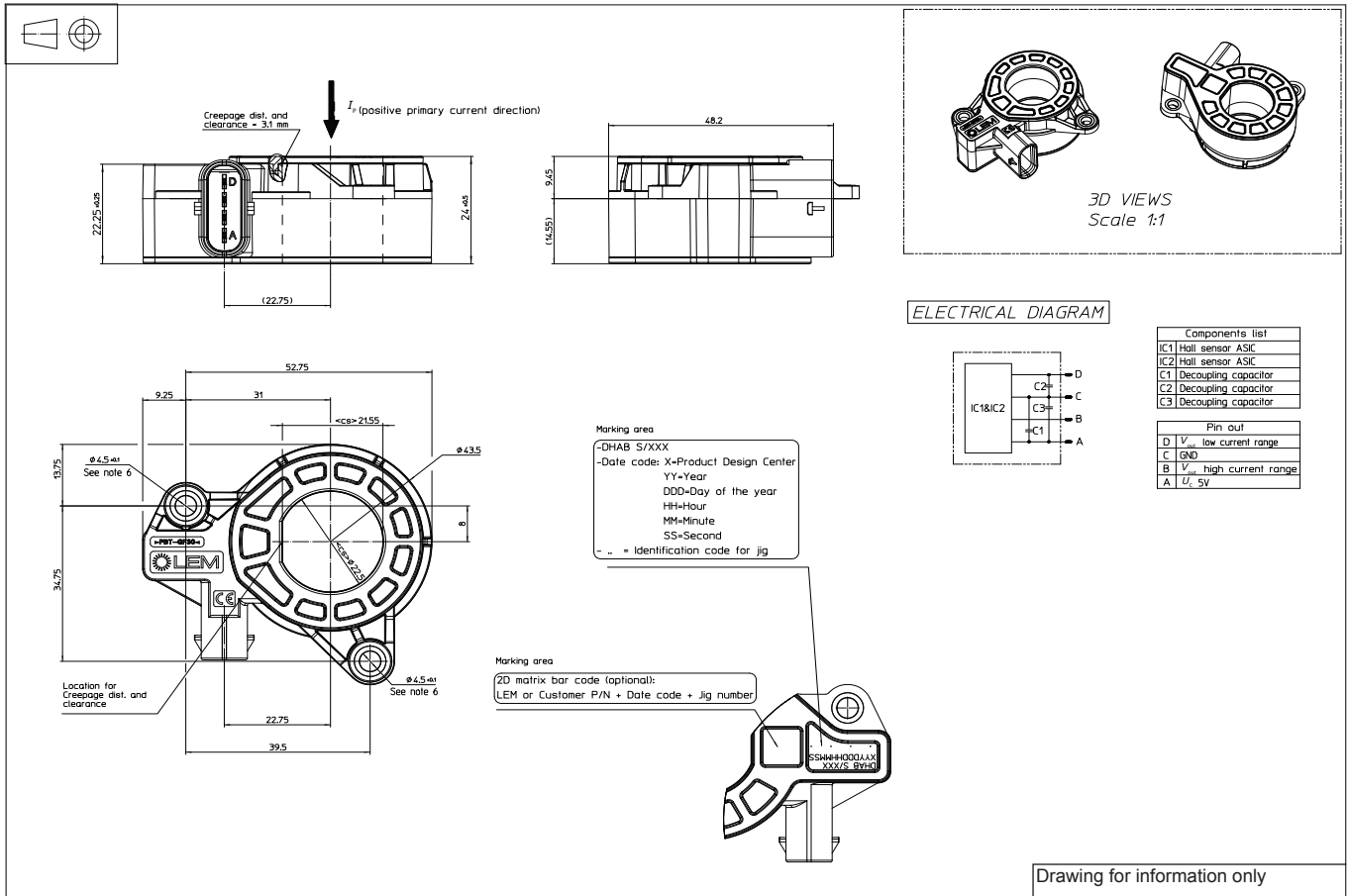

Fig. 1: Principle of the open loop transducer

Dimensions (in mm)

Mechanical characteristics

- Plastic case >PBT-GF30<
- Magnetic core Channel 1: FeNi alloy
Channel 2: FeSi alloy
- Electrical terminal coating Brass tin plated
- Mass 82 g
- Degrees of protection provided by enclosure: IP6K9K

Mounting recommendation

- Mating connector P/N TYCO 1-1456426-5
- Max assembly torque 2.5 N·m (for M4 × 0.7)
- Clamping force must be applied on the compression limiter
- Soldering type N/A

Remark

- $V_{out} > V_0$ when I_p flows in the positive direction (see arrow on drawing).

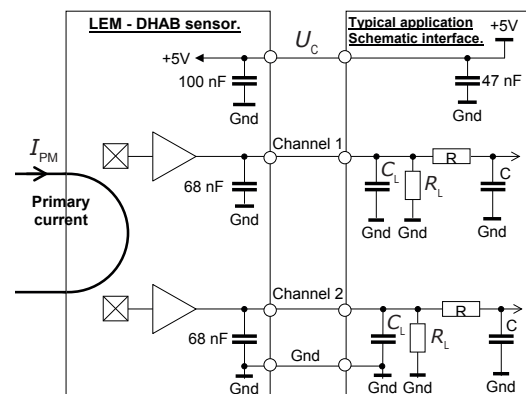
System architecture (example)

- $R_L > 10 \text{ k}\Omega$ optional resistor for signal line diagnostic
- $C_L < 100 \text{ nF}$ EMC protection
- RC Low pass filter EMC protection (optional)

Absolute ratings (not operating)

Parameter	Symbol	Unit	Specification			Conditions
			Min	Typical	Max	
Maximum supply voltage	U_C	V	-14		14	
Ambient storage temperature	T_S	°C	-40		125	
Electrostatic discharge voltage	U_{ESD}	kV			8	IEC 61000-4-2 - ISO 10605
Rms voltage for AC insulation test, 50 Hz, 1 min	U_d	kV			2.5	ISO 16750-2
Creepage distance	d_{CP}	mm		3.1		
Clearance	d_{CI}	mm		3.1		
Comparative tracking index	CTI			PLC3		
Maximum output current	I_{out}	mA	-10		10	Continuous
Maximum output voltage (Analog)		V	-14		14	Output over voltage, 1 min @ $T_A = 25\text{ °C}$
Insulation resistance	R_{IS}	MΩ	500			500 V DC, ISO 16750-2
Output short circuit maximum duration	t_c	s			120	

Operating characteristics in nominal range (I_{PN})

Parameter	Symbol	Unit	Specification			Conditions
			Min	Typical	Max	
Electrical Data						
Supply voltage ¹⁾	U_C	V	4.75	5	5.25	
Current consumption	I_C	mA		15	20	
Maximum output current	I_{out}	mA	-1		1	
Load resistance	R_L	KΩ	10			
Capacitive loading	C_L	nF	1		100	
Ambient operating temperature	T_A	°C	-10		65	High accuracy
			-40		125	Reduced accuracy
Performance Data channel 1						
Primary current, measuring range	$I_{PM\ channel\ 1}$	A	-25		25	
Primary nominal DC or rms current	$I_{PN\ channel\ 1}$	A	-25		25	@ $T_A = 25\text{ °C}$
Offset voltage	V_O	V		2.5		@ $U_C = 5\text{ V}$
Sensitivity	G	mV/A		80		@ $U_C = 5\text{ V}$
Resolution		mV		2.5		@ $U_C = 5\text{ V}$
Output clamping voltage min ¹⁾	V_{SZ}	V	0.2	0.25	0.3	@ $U_C = 5\text{ V}$
Output clamping voltage max ¹⁾		V	4.7	4.75	4.8	@ $U_C = 5\text{ V}$
Output internal resistance	R_{out}	Ω		1	10	
Frequency bandwidth ²⁾	BW	Hz		70		@ -3 dB
Power up time		ms			1	
Setting time after overload	t_s	ms			10	
Ratiometricity error	ϵ_r	%	-0.6		0.6	
Output voltage noise peak-peak	$V_{no\ pp}$	mV	-10		10	
Performance Data channel 2						
Primary current, measuring range	$I_{PM\ channel\ 2}$	A	-200		200	
Primary nominal DC or rms current	$I_{PN\ channel\ 2}$	A	-200		200	@ $T_A = 25\text{ °C}$
Offset voltage	V_O	V		2.5		@ $U_C = 5\text{ V}$
Sensitivity	G	mV/A		10		@ $U_C = 5\text{ V}$
Resolution		mV		2.5		@ $U_C = 5\text{ V}$
Output clamping voltage min ¹⁾	V_{SZ}	V	0.2	0.25	0.3	@ $U_C = 5\text{ V}$
Output clamping voltage max ¹⁾		V	4.7	4.75	4.8	@ $U_C = 5\text{ V}$
Output internal resistance	R_{out}	Ω		1	10	
Frequency bandwidth ²⁾	BW	Hz		70		@ -3 dB
Power up time		ms			1	
Setting time after overload	t_s	ms			10	
Ratiometricity error	ϵ_r	%	-0.6		0.6	
Output voltage noise peak-peak	$V_{no\ pp}$	mV	-10		10	

Notes: ¹⁾ The output voltage V_{out} is fully ratiometric. The offset and sensitivity are dependent on the supply voltage U_C relative to the following formula:

$$I_p = \left(\frac{5}{U_C} \times V_{out} - V_O \right) \times \frac{1}{G} \text{ with } G \text{ in (V/A)}$$

²⁾ Primary current frequencies must be limited in order to avoid excessive heating of the busbar, magnetic core and the ASIC (see feature paragraph in page 1.)

Accuracy

Channel 1

Parameter	Symbol	Unit	Specification			Conditions
			Min	Typical	Max	
Electrical Data						
Electrical offset current	I_{OE}	A		±0.07		@ $T_A = 25\text{ °C}$
Magnetic offset current	I_{OM}	A		±0.03		@ $T_A = 25\text{ °C}$
Offset current	I_O	A	-0.15		0.15	@ $T_A = 25\text{ °C}$
			-0.23		0.23	@ $-10\text{ °C} < T^{\circ} < 65\text{ °C}$
			-0.35		0.35	@ $-40\text{ °C} < T^{\circ} < 125\text{ °C}$
Sensitivity error	ϵ_G	%		±0.4		@ $T_A = 25\text{ °C}$
				±1.0		@ $-10\text{ °C} < T^{\circ} < 65\text{ °C}$
				±1.5		@ $-40\text{ °C} < T^{\circ} < 125\text{ °C}$
Linearity error	ϵ_L	%		±0.5		@ $T_A = 25\text{ °C}$, @ $U_c = 5\text{ V}$, of full range

Accuracy table

Parameter	Symbol	Unit	Temperature					
			-40 °C	-20 °C	0 °C	25 °C	65 °C	125 °C
Accuracy @ 0 A	X	A	0.35	0.29	0.23	0.15	0.23	0.35
Accuracy @ ±12 A			0.70	0.58	0.47	0.32	0.47	0.70
Accuracy @ ±25 A			0.90	0.76	0.62	0.45	0.63	0.90

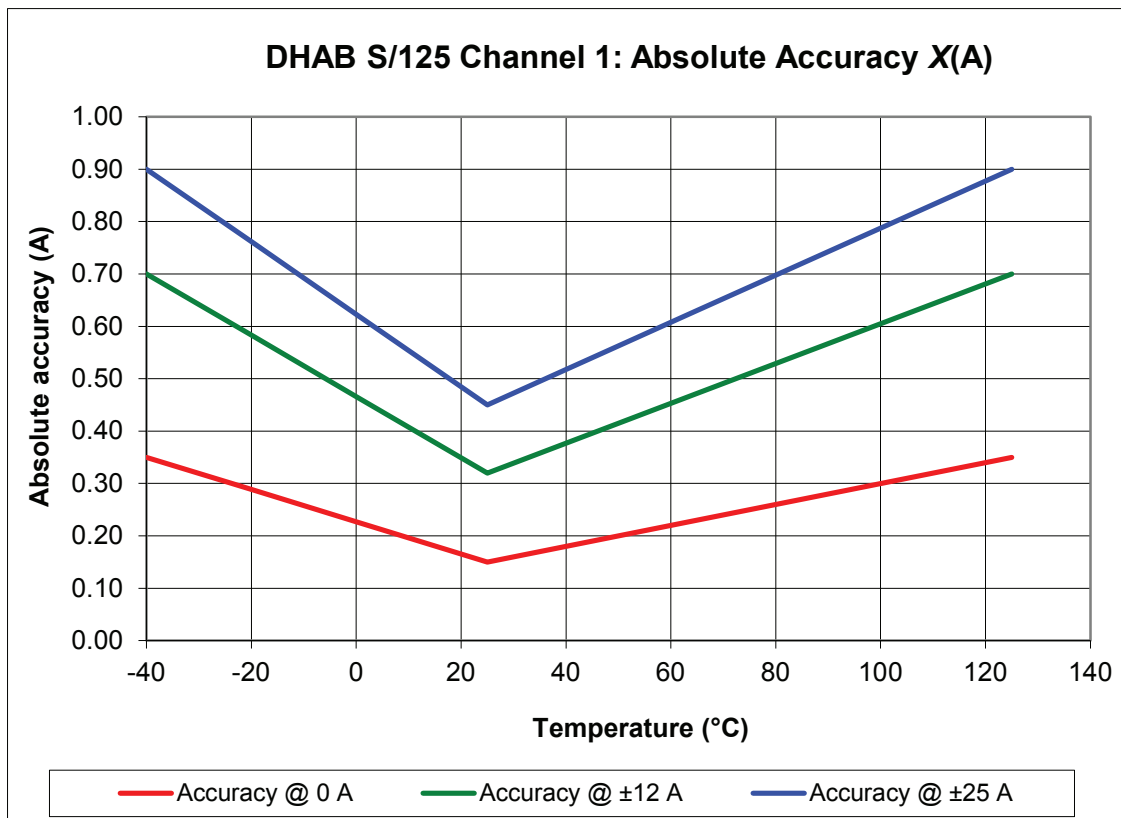

Accuracy

Channel 2

Parameter	Symbol	Unit	Specification			Conditions
			Min	Typical	Max	
Electrical Data						
Electrical offset current	I_{OE}	A		±0.6		@ $T_A = 25\text{ °C}$
Magnetic offset current	I_{OM}	A		±0.25		@ $T_A = 25\text{ °C}$
Offset current	I_O	A	-1		1	@ $T_A = 25\text{ °C}$
			-1.32		1.20	@ $-10\text{ °C} < T^\circ < 65\text{ °C}$
			-1.5		1.5	@ $-40\text{ °C} < T^\circ < 125\text{ °C}$
Sensitivity error	ϵ_G	%		±0.4		@ $T_A = 25\text{ °C}$
				±0.8		@ $-10\text{ °C} < T^\circ < 65\text{ °C}$
				±1.2		@ $-40\text{ °C} < T^\circ < 125\text{ °C}$
Linearity error	ϵ_L	%		±0.5		@ $T_A = 25\text{ °C}$, @ $U_c = 5\text{ V}$, of full range

Accuracy table

Parameter	Symbol	Unit	Temperature					
			-40 °C	-20 °C	0 °C	25 °C	65 °C	125 °C
Accuracy @ 0 A	X	A	1.50	1.35	1.19	1.00	1.20	1.50
Accuracy @ ±100 A			4.00	3.54	3.08	2.50	3.10	4.00
Accuracy @ ±200 A			7.00	5.77	4.54	3.00	4.60	7.00

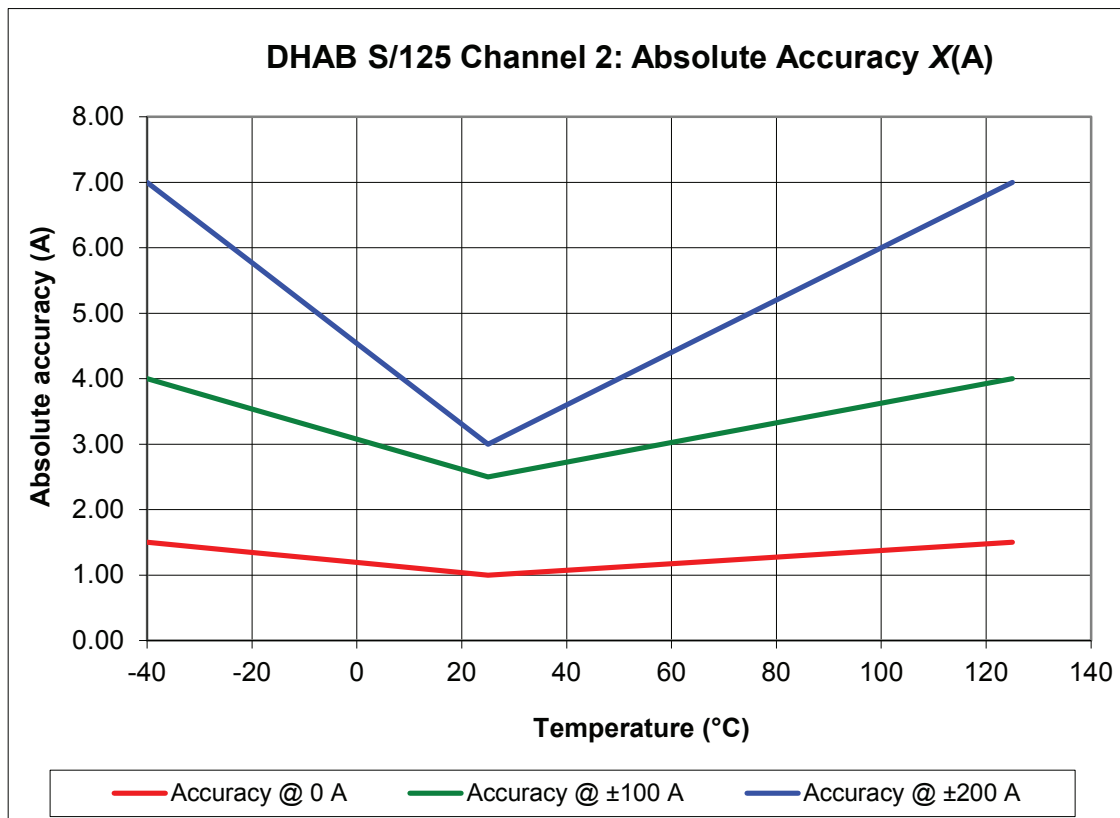

PERFORMANCES PARAMETERS DEFINITIONS

Primary current definition:

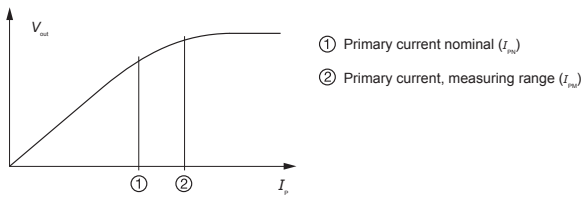

Definition of typical, minimum and maximum values:

Minimum and maximum values for specified limiting and safety conditions have to be understood as such as values shown in “typical” graphs. On the other hand, measured values are part of a statistical distribution that can be specified by an interval with upper and lower limits and a probability for measured values to lie within this interval. Unless otherwise stated (e.g. “100 % tested”), the LEM definition for such intervals designated with “min” and “max” is that the probability for values of samples to lie in this interval is 99.73 %. For a normal (Gaussian) distribution, this corresponds to an interval between -3 sigma and +3 sigma. If “typical” values are not obviously mean or average values, those values are defined to delimit intervals with a probability of 68.27 %, corresponding to an interval between -sigma and +sigma for a normal distribution. Typical, minimum and maximum values are determined during the initial characterization of a product.

Output noise voltage:

The output voltage noise is the result of the noise floor of the Hall elements and the linear amplifier.

Magnetic offset:

The magnetic offset is the consequence of an over-current on the primary side. It's defined after an excursion of I_{PN} .

Linearity:

The maximum positive or negative discrepancy with a reference straight line $V_{out} = f(I_{pr})$.

Unit: linearity (%) expressed with full scale of I_{PN} .

Response time (delay time) t_r :

The time between the primary current signal (I_{PN}) and the output signal reach at 90 % of its final value.

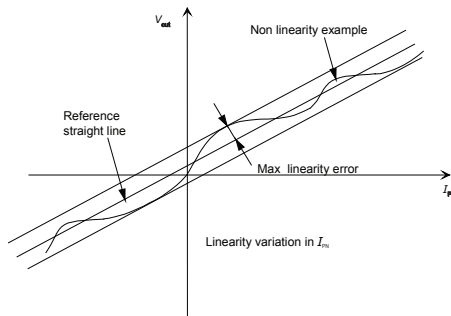

Sensitivity:

The transducer's sensitivity G is the slope of the straight line $V_{out} = f(I_{pr})$, it must establish the relation:

$$V_{out}(I_{pr}) = U_c/5 (G \times I_{pr} + V_o)$$

Offset with temperature:

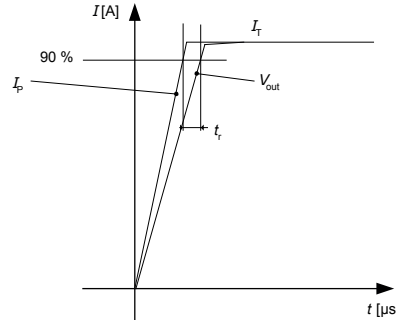

The error of the offset in the operating temperature is the variation of the offset in the temperature considered with the initial offset at 25 °C.

The offset variation I_{OT} is a maximum variation the offset in the temperature range:

$$I_{OT} = I_{OE \max} - I_{OE \min}$$

The offset drift TCI_{OEAV} is the I_{OT} value divided by the temperature range.

Sensitivity with temperature:

The error of the sensitivity in the operating temperature is the relative variation of sensitivity with the temperature considered with the initial offset at 25 °C.

The sensitivity variation G_T is the maximum variation (in ppm or %) of the sensitivity in the temperature range:

$$G_T = (\text{Sensitivity max} - \text{Sensitivity min}) / \text{Sensitivity at } 25 \text{ }^\circ\text{C}$$

The sensitivity drift TCG_{AV} is the G_T value divided by the temperature range. Deeper and detailed info available is our LEM technical sales offices (www.lem.com).

Offset voltage @ $I_{pr} = 0$ A:

The offset voltage is the output voltage when the primary current is zero. The ideal value of V_o is $U_c/2$ at $U_c = 5$ V. So, the difference of $V_o - U_c/2$ is called the total offset voltage error. This offset error can be attributed to the electrical offset (due to the resolution of the ASIC quiescent voltage trimming), the magnetic offset, the thermal drift and the thermal hysteresis. Deeper and detailed info available is our LEM technical sales offices (www.lem.com).

Environmental test specifications:

Name	Standard	Conditions
Low temperature storage test	ISO 16750-4 IEC 60068-2-1	-40 °C, 240 hours; no power supply
Low temperature operation test	ISO 16750-4 IEC 60068-2-1 Ad	-40 °C, 240 hours; power ON
HTOE (high temperature operating endurance test)	ISO 16750-4 IEC 60068-2-2 Bd	1000 hours; power supply @ 125 °C
Powered thermal cycle endurance	IEC 60068-2-14 Nb	-40 °C (20 min), +125 °C (20 min), 600 cycles; offset monitored
Thermal shock	IEC 60068-2-14 Na	-40 °C (20 min soak) / 125 °C (20 min soak), 1000 cycles, with connectors => 667 h (28 days)
High temperature and humidity endurance	JESD22-A101	1000 hours; 85 °C / 85 % HR; power ON; Monitored once a day Accuracy criteria: $X < 3 \% @ 25^{\circ} C @ I_p \text{ max CH1}$ Accuracy criteria: $X < 3 \% @ 25^{\circ} C @ I_p \text{ max CH2}$
Salt fog	IEC 60068-2-11	96 hours @ 35 °C, 5 % of salt water solution, characterization before and after test only at 25 °C and U_c nominal
Mechanical tests		
Vibration in temperature	ISO 16750-3 § 4.1.2.4 mass suspended	Continuous monitoring: offset
Shocks	ISO 16750-3 § 4.2	Power ON. Profile 1 (500 m·s ⁻² ; 11 ms) 10 shocks per axe Half sinusoidal pulse
Free Fall test	ISO 16750-3	3 axis, 2 directions by axis; 1 sample per axis; 1 m.; concrete floor
EMC test		
BCI (bulk current injection)	ISO 11452-4 Annex E.1.1, Table E.1	From 1 to 400 MHz. Level 1: 60 mA; Functional class: A Level 2: 100 mA; Functional class: A Level 4: 200 mA; Functional class: B
Radiated electromagnetic immunity	ISO 11452-2 GMW 3097 (04.2012) table 12 p.21 (level 2)	Level: 100 V/m (rms); from 400 M to 1 GHz Functional class: A Level: 70 V/m (rms) from 1 G to 2 GHz Functional class: A
Emission	CISPR 25	Table 9, Class 5 by default Freq = 150 kHz to 2.5 GHz
ESD not supplied	IEC 61000-4-2 + ISO 10605 (07/2008)	Contact discharge: ±4 kV & ±8 kV Air discharge: ± 15 kV Functionnal class: A after reconnection (150 pF, 330 Ω)
Connector tests		
Connector to connector engagement force	GMW 3191 § 4.11	
Locked connector disengagement force	GMW 3191 § 4.13	
Unlocked connector disengagement force	GMW 3191 § 4.14	