

Current Transducer CKSR/SP1 series

$I_{PN} = 25, 50 A$

Ref: CKSR 25-NP/SP1, CKSR 50-NP/SP1

For the electronic measurement of current: DC, AC, pulsed..., with galvanic separation between the primary and the secondary circuit.

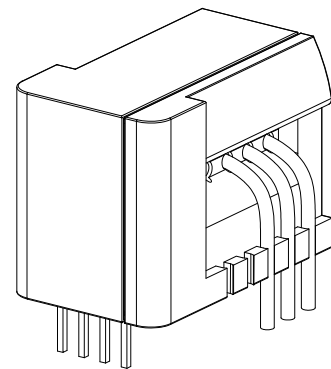

Features

- Closed loop (compensated) multi-range current transducer
- Voltage output
- Single supply
- Compact design for PCB mounting.

Special feature

- Dedicated 3 primary conductors configuration.

Advantages

- Very low temperature coefficient of offset
- Very good dv/dt immunity
- Higher creepage distance/clearance
- Reduced height
- Reference pin with two modes: Ref IN and Ref OUT
- Extended measuring range for unipolar measurement.

Applications

- AC variable speed and servo motor drives
- Static converters for DC motor drives
- Battery supplied applications
- Uninterruptible Power Supplies (UPS)
- Switched Mode Power Supplies (SMPS)
- Power supplies for welding applications
- Solar inverters.

Standards

- EN 50178: 1997
- IEC 60950-1: 2006
- IEC 61010-1: 2010
- IEC 61326-1: 2012
- UL 508: 2010.

Application Domain

- Industrial.

Absolute maximum ratings

Parameter	Symbol	Unit	Value
Supply voltage	U_C	V	7
Primary conductor temperature	T_B	°C	110
Maximum primary current	$I_{P\ max}$	A	$20 \times I_{PN}$
ESD rating, Human Body Model (HBM)	U_{ESD}	kV	4

Stresses above these ratings may cause permanent damage. Exposure to absolute maximum ratings for extended periods may degrade reliability.

UL 508: Ratings and assumptions of certification

File # E189713 Volume: 2 Section: 1

Standards

- CSA C22.2 NO. 14-10 INDUSTRIAL CONTROL EQUIPMENT - Edition 11 - Revision Date 2011/08/01
- UL 508 STANDARD FOR INDUSTRIAL CONTROL EQUIPMENT - Edition 17 - Revision Date 2010/04/15

Ratings

Parameter	Symbol	Unit	Value
Primary involved potential		V AC/DC	1000
Max surrounding air temperature	T_A	°C	85
Primary current	I_P	A	According to series primary currents
Secondary supply voltage	U_C	V DC	7
Output voltage	V_{out}	V	0 to 5

Conditions of acceptability

When installed in the end-use equipment, consideration shall be given to the following:

- 1 - These devices must be mounted in a suitable end-use enclosure.*
- 4 - CKSR series intended to be mounted on the printed circuit wiring board of the end-use equipment (with a minimum CTI of 100).*
- 5 - CKSR series shall be used in a pollution degree 2.*
- 8 - Low voltage circuits are intended to be powered by a circuit derived from an isolating source (such as transformer, optical isolator, limiting impedance or electro-mechanical relay) and having no direct connection back to the primary circuit (other than through the grounding means).*
- 11 - CKSR series: based on results of temperature tests, in the end-use application, a maximum of 100 °C cannot be exceeded at soldering joint between primary coil pin and soldering point (corrected to the appropriate evaluated max. surrounding air).*

Marking

Only those products bearing the UL or UR Mark should be considered to be Listed or Recognized and covered under UL's Follow-Up Service. Always look for the Mark on the product.

Insulation coordination

Parameter	Symbol	Unit	Value	Comment
Rms voltage for AC insulation test, 50 Hz, 1 min	U_d	kV	4.3	
Impulse withstand voltage 1.2/50 μ s	\hat{U}_w	kV	8	
Partial discharge extinction rms voltage @ 10 pC	U_e	V	1000	
Clearance (pri. - sec.)	d_{Cl}	mm	8.2	Shortest internal distance through air (Note ¹⁾)
Creepage distance (pri. - sec.)	d_{Cl}	mm	8.2	Shortest internal path along device body (Note ¹⁾)
Clearance (pri. - sec.)	d_{Cl}	mm	12.3	Shortest external distance through air
Creepage distance (pri. - sec.)	d_{Cl}	mm	12.3	Shortest external path along device body
Case material	-	-	V0 according to UL 94	
Comparative tracking index	CTI		600	
Application example	-	-	1000 V CAT II PD2	Reinforced insulation, non uniform field according to IEC 61010-1
Application example	-	-	600 V CAT III PD2	Reinforced insulation, non uniform field according to EN 50178
Application example	-	-	1000 V CAT III PD2	Simple insulation, non uniform field according to EN 50178

Note: ¹⁾ Inside device enclosure providing protection IP5x.

Environmental and mechanical characteristics

Parameter	Symbol	Unit	Min	Typ	Max	Comment
Ambient operating temperature	T_A	°C	-40		105	
Ambient storage temperature	T_S	°C	-55		105	
Mass	m	g		9		

Electrical data CKSR 25-NP/SP1

At $T_A = 25\text{ °C}$, $U_C = +5\text{ V}$, $N_p = 1$ turn, $R_L = 10\text{ k}\Omega$ internal reference unless otherwise noted (see Min, Max, typ. definition paragraph in page 9).

Parameter	Symbol	Unit	Min	Typ	Max	Comment
Primary nominal rms current	I_{PN}	A		25		Apply derating according to fig. 13
Primary current, measuring range	I_{PM}	A	-85		85	
Number of primary turns	N_p			1,2,3		
Supply voltage	U_C	V	4.75	5	5.25	
Current consumption	I_C	mA		$15 + \frac{I_P\text{ (mA)}}{N_s}$	$20 + \frac{I_P\text{ (mA)}}{N_s}$	$N_s = 1731$ turns
Reference voltage @ $I_p = 0\text{ A}$	V_{ref}	V	2.495	2.5	2.505	Internal reference
External reference voltage	V_{ref}	V	0		4	
Output voltage	V_{out}	V	0.375		4.625	
Output voltage @ $I_p = 0\text{ A}$	V_{out}	V		V_{ref}		
Electrical offset voltage	V_{OE}	mV	-1.35		1.35	100 % tested $V_{out} - V_{ref}$
Electrical offset current referred to primary	I_{OE}	mA	-54		54	100 % tested
Temperature coefficient of V_{ref}	TCV_{ref}	ppm/K		± 5	± 50	Internal reference
Temperature coefficient of V_{out} @ $I_p = 0\text{ A}$	TCV_{out}	ppm/K		± 1.4	± 4	ppm/K of 2.5 V -40 °C ... 105 °C (at ± 6 Sigma)
Theoretical sensitivity	G_{th}	mV/A		25		$625\text{ mV}/I_{PN}$
Sensitivity error	ϵ_G	%	-0.7		0.7	100 % tested
Temperature coefficient of G	TCG	ppm/K			± 40	-40 °C ... 105 °C
Linearity error	ϵ_L	% of I_{PN}	-0.1		0.1	
Magnetic offset current ($10 \times I_{PN}$) referred to primary	I_{OM}	A	-0.1		0.1	
Output rms current noise (spectral density) 100 Hz ... 100 kHz referred to primary	I_{no}	$\mu\text{A}/\text{Hz}^{1/2}$		20		$R_L = 1\text{ k}\Omega$
Peak-peak output ripple at oscillator frequency $f = 450\text{ kHz}$ (typ.)	-	mV		10	40	$R_L = 1\text{ k}\Omega$
Reaction time @ 10 % of I_{PN}	t_{ra}	μs			0.3	$R_L = 1\text{ k}\Omega$, $di/dt = 68\text{ A}/\mu\text{s}$
Step response time to 90 % of I_{PN}	t_r	μs			0.3	$R_L = 1\text{ k}\Omega$, $di/dt = 68\text{ A}/\mu\text{s}$
Frequency bandwidth ($\pm 1\text{ dB}$)	BW	kHz	200			$R_L = 1\text{ k}\Omega$
Frequency bandwidth ($\pm 3\text{ dB}$)	BW	kHz	300			$R_L = 1\text{ k}\Omega$
Overall accuracy	X_G	% of I_{PN}			1	
Overall accuracy @ $T_A = 85\text{ °C}$ (105 °C)	X_G	% of I_{PN}			1.35 (1.45)	
Accuracy	X	% of I_{PN}			0.8	
Accuracy @ $T_A = 85\text{ °C}$ (105 °C)	X	% of I_{PN}			1.15 (1.25)	

Electrical data CKSR 50-NP/SP1

At $T_A = 25\text{ °C}$, $U_C = +5\text{ V}$, $N_P = 1$ turn, $R_L = 10\text{ k}\Omega$ internal reference U_C unless otherwise noted (see Min, Max, typ. definition paragraph in page 9).

Parameter	Symbol	Unit	Min	Typ	Max	Comment
Primary nominal rms current	I_{PN}	A		50		Apply derating according to fig. 14
Primary current, measuring range	I_{PM}	A	-150		150	
Number of primary turns	N_P			1,2,3		
Supply voltage	U_C	V	4.75	5	5.25	
Current consumption	I_C	mA		$15 + \frac{I_P\text{ (mA)}}{N_S}$	$20 + \frac{I_P\text{ (mA)}}{N_S}$	$N_S = 966$ turns
Reference voltage @ $I_P = 0\text{ A}$	V_{ref}	V	2.495	2.5	2.505	Internal reference
External reference voltage	V_{ref}	V	0		4	
Output voltage	V_{out}	V	0.375		4.625	
Output voltage @ $I_P = 0\text{ A}$	V_{out}	V		V_{ref}		
Electrical offset voltage	V_{OE}	mV	-0.725		0.725	100 % tested $V_{out} - V_{ref}$
Electrical offset current referred to primary	I_{OE}	mA	-58		58	100 % tested
Temperature coefficient of V_{ref}	TCV_{REF}	ppm/K		± 5	± 50	Internal reference
Temperature coefficient of V_{out} @ $I_P = 0\text{ A}$	TCV_{out}	ppm/K		± 0.7	± 3	ppm/K of 2.5 V -40 °C ... 105 °C (at ± 6 Sigma)
Theoretical sensitivity	G_{th}	mV/A		12.5		$625\text{ mV}/I_{PN}$
Sensitivity error	ϵ_G	%	-0.7		0.7	100 % tested
Temperature coefficient of G	TCG	ppm/K			± 40	-40 °C ... 105 °C
Linearity error	ϵ_L	% of I_{PN}	-0.1		0.1	
Magnetic offset current ($10 \times I_{PN}$) referred to primary	I_{OM}	A	-0.1		0.1	
Output rms current noise (spectral density) 100 Hz ... 100 kHz referred to primary	I_{no}	$\mu\text{A}/\text{Hz}^{1/2}$		20		$R_L = 1\text{ k}\Omega$
Peak-peak output ripple at oscillator frequency $f = 450\text{ kHz}$ (typ.)	-	mV		5	20	$R_L = 1\text{ k}\Omega$
Reaction time @ 10 % of I_{PN}	t_{ra}	μs			0.3	$R_L = 1\text{ k}\Omega$, $di/dt = 100\text{ A}/\mu\text{s}$
Step response time to 90 % of I_{PN}	t_r	μs			0.3	$R_L = 1\text{ k}\Omega$, $di/dt = 100\text{ A}/\mu\text{s}$
Frequency bandwidth ($\pm 1\text{ dB}$)	BW	kHz	200			$R_L = 1\text{ k}\Omega$
Frequency bandwidth ($\pm 3\text{ dB}$)	BW	kHz	300			$R_L = 1\text{ k}\Omega$
Overall accuracy	X_G	% of I_{PN}			0.9	
Overall accuracy @ $T_A = 85\text{ °C}$ (105 °C)	X_G	% of I_{PN}			1.2 (1.3)	
Accuracy	X	% of I_{PN}			0.8	
Accuracy @ $T_A = 85\text{ °C}$ (105 °C)	X	% of I_{PN}			1.1 (1.3)	

Typical performance characteristics CKSR 25-NP/SP1

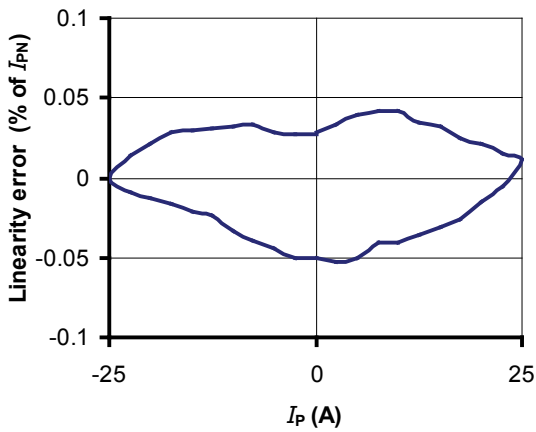

Figure 1: Linearity error

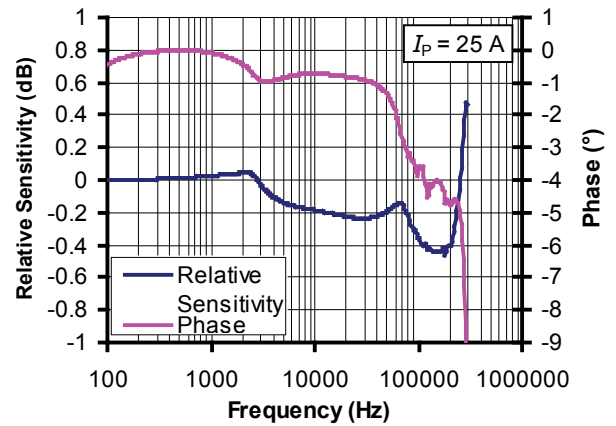

Figure 2: Frequency response

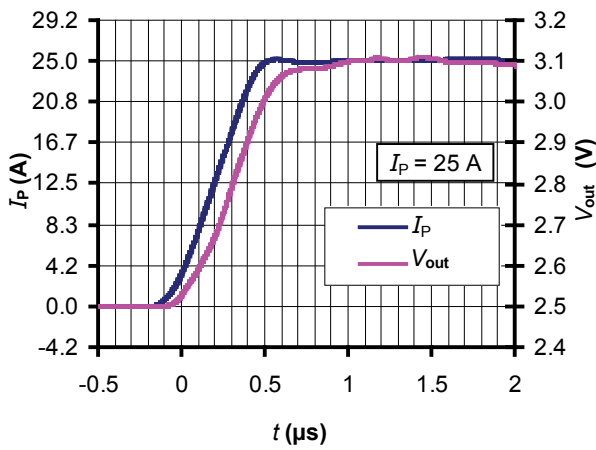

Figure 3: Step response

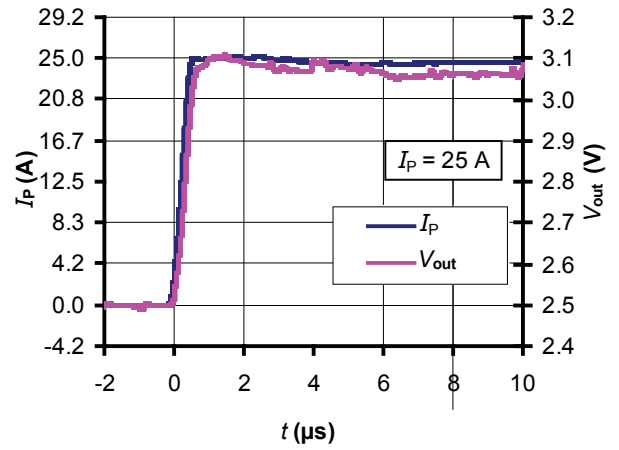

Figure 4: Step response

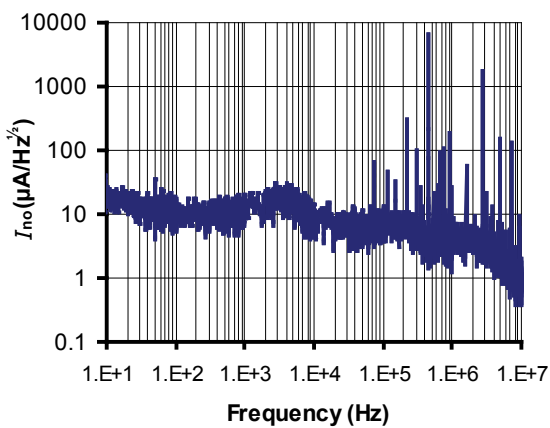

Figure 5: Input referred noise

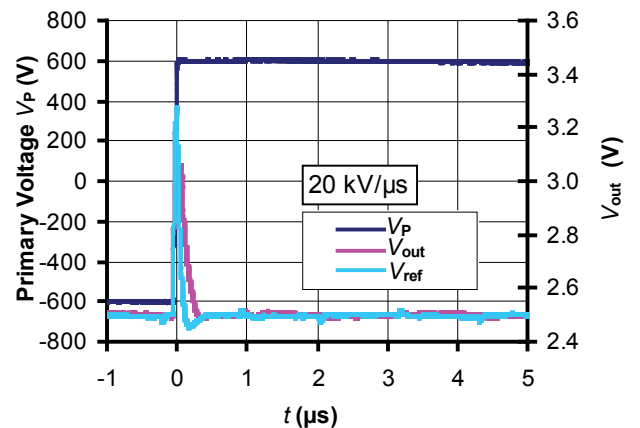

Figure 6: dv/dt

Typical performance characteristics CKSR 50-NP/SP1

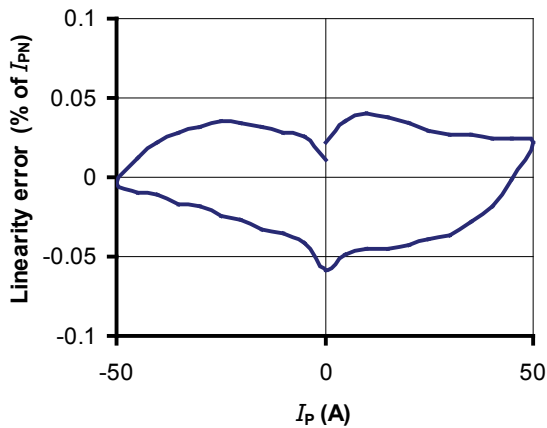

Figure 7: Linearity error

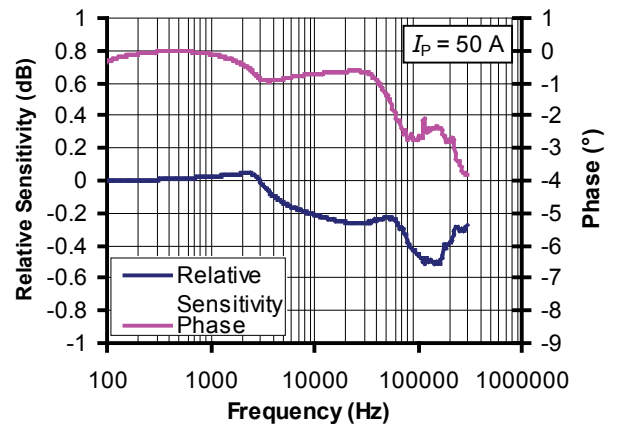

Figure 8: Frequency response

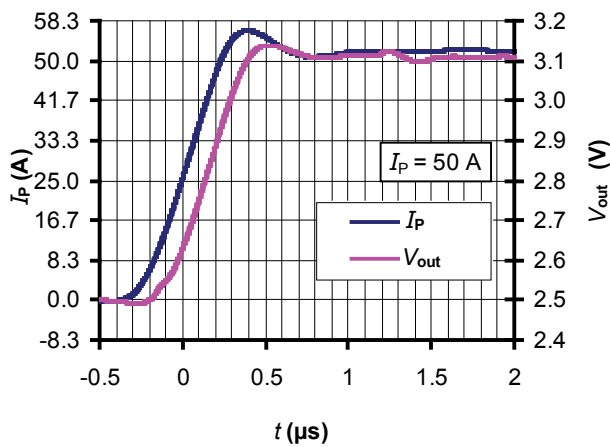

Figure 9: Step response

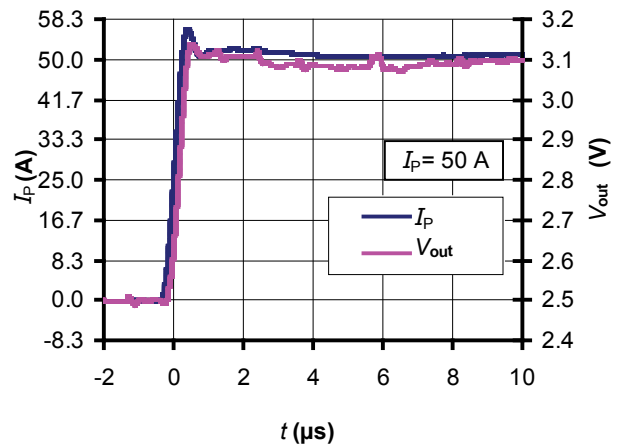

Figure 10: Step response

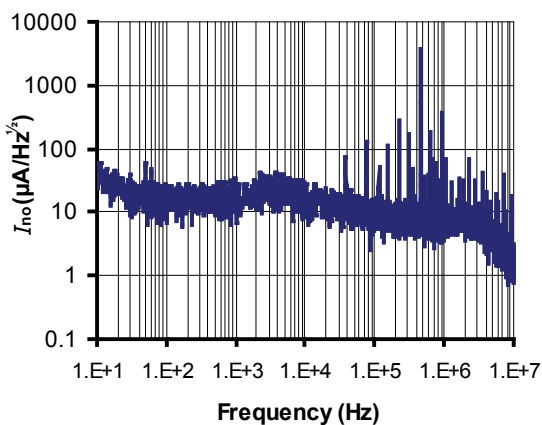

Figure 11: Input referred noise

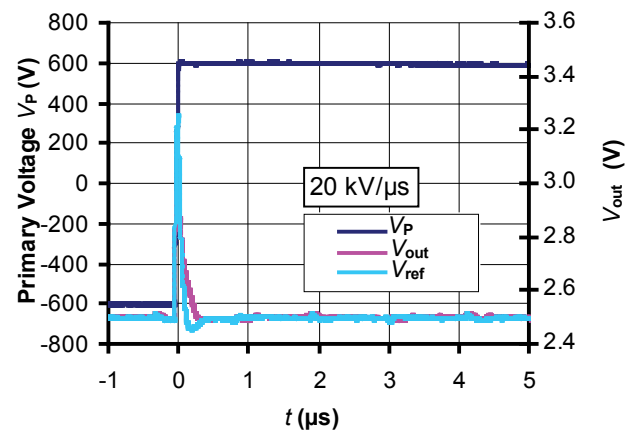

Figure 12: dv/dt

Maximum continuous DC primary current

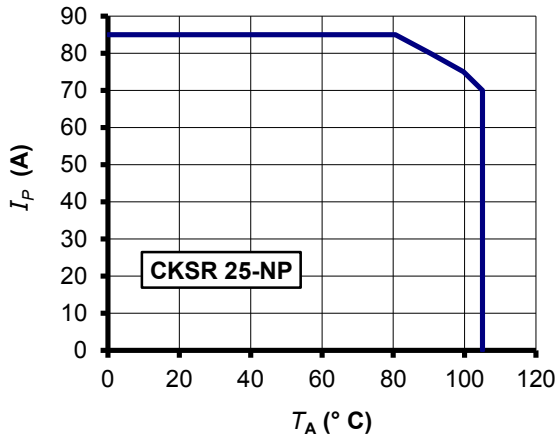

Figure 13: I_P vs T_A for CKSR 25-NP/SP1

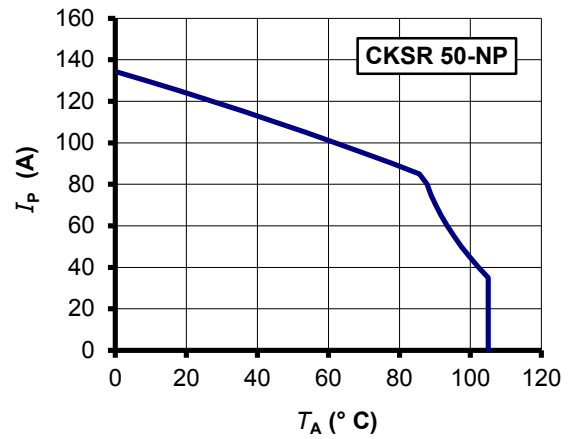

Figure 14: I_P vs T_A for CKSR 50-NP/SP1

The maximum continuous DC primary current plot shows the boundary of the area for which all the following conditions are true:

- $I_P < I_{PM}$
- Junction temperature $T_J < 125\text{ °C}$
- Primary conductor temperature $< 110\text{ °C}$
- Resistor power dissipation $< 0.5 \times \text{rated power}$

Frequency derating

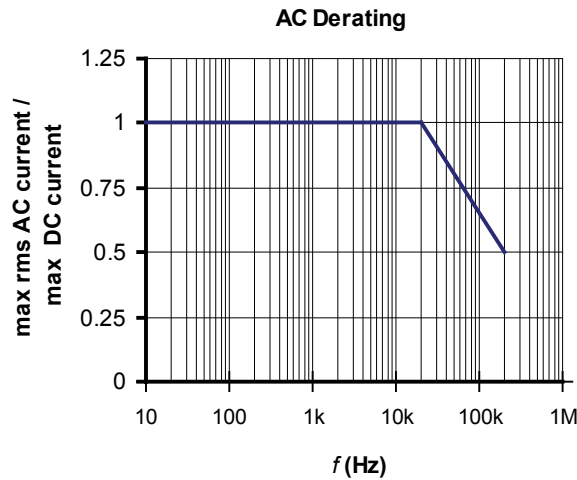

Figure 15: Maximum rms AC primary current / maximum DC primary current vs frequency

Performance parameters definition

Ampere-turns and amperes

The transducer is sensitive to the primary current linkage Θ_p (also called ampere-turns).

$$\Theta_p = N_p I_p (\text{At})$$

Where N_p the number of primary turn (depending on the connection of the primary jumpers)

Caution: As most applications will use the transducer with only one single primary turn ($N_p = 1$), much of this datasheet is written in terms of primary current instead of current linkages. However, the ampere-turns (At) unit is used to emphasis that current linkages are intended and applicable.

Transducer simplified model

The static model of the transducer at temperature T_A is:

$$V_{\text{out}} = G \Theta_p + \varepsilon$$

In which $\varepsilon =$

$$V_{\text{OE}} + V_{\text{OT}}(T_A) + \varepsilon_G \cdot \Theta_p \cdot G + \varepsilon_L(\Theta_{P_{\text{max}}}) \cdot \Theta_{P_{\text{max}}} \cdot G + TCG \cdot (T_A - 25) \cdot \Theta_p \cdot G$$

With:

- $\Theta_p = N_p I_p$: primary current linkage (At)
- $\Theta_{P_{\text{max}}}$: max primary current linkage applied to the transducer
- V_{out} : output voltage (V)
- T_A : ambient operating temperature ($^{\circ}\text{C}$)
- V_{OE} : electrical offset voltage (V)
- $V_{\text{OT}}(T_A)$: temperature variation of V_{O} at temperature T_A ($^{\circ}\text{C}$)
- G : sensitivity of the transducer (V/At)
- TCG : temperature coefficient of G
- ε_G : sensitivity error
- $\varepsilon_L(\Theta_{P_{\text{max}}})$: linearity error for $\Theta_{P_{\text{max}}}$

This model is valid for primary ampere-turns Θ_p between $-\Theta_{P_{\text{max}}}$ and $+\Theta_{P_{\text{max}}}$ only.

Definition of typical, minimum and maximum values

Minimum and maximum values for specified limiting and safety conditions have to be understood as such as well as values shown in "typical" graphs. On the other hand, measured values are part of a statistical distribution that can be specified by an interval with upper and lower limits and a probability for measured values to lie within this interval.

Unless otherwise stated (e.g. "100 % tested"), the LEM definition for such intervals designated with "min" and "max" is that the probability for values of samples to lie in this interval is 99.73 %. For a normal (Gaussian) distribution, this corresponds to an interval between -3 sigma and +3 sigma. If "typical" values are not obviously mean or average values, those values are defined to delimit intervals with a probability of 68.27 %, corresponding to an interval between -sigma and +sigma for a normal distribution.

Typical, minimum and maximum values are determined during the initial characterization of a product.

Sensitivity and linearity

To measure sensitivity and linearity, the primary current (DC) is cycled from 0 to I_{P1} , then to $-I_{P1}$ and back to 0 (equally spaced $I_{P1}/10$ steps). The sensitivity G is defined as the slope of the linear regression line for a cycle between $\pm I_{P1}$. The linearity error ε_L is the maximum positive or negative difference between the measured points and the linear regression line, expressed in % of I_{P1} .

Magnetic offset

The magnetic offset current I_{OM} is the consequence of a current on the primary side ("memory effect" of the transducer's ferro-magnetic parts).

It is measured using the following primary current cycle. I_{OM} depends on the current value I_{P1} ($I_{P1} > I_{PM}$).

$$I_{\text{OM}} = \frac{V_{\text{out}}(t_1) - V_{\text{out}}(t_2)}{2} \cdot \frac{1}{G_{\text{th}}}$$

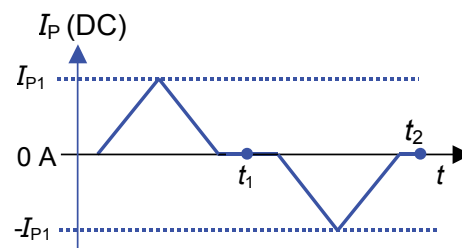

Figure 16: Current cycle used to measure magnetic and electrical offset (transducer supplied)

Performance parameters definition (continued)

Electrical offset

The electrical offset voltage V_{OE} can either be measured when the ferro-magnetic parts of the transducer are:

- completely demagnetized, which is difficult to realize,
- or in a known magnetization state, like in the current cycle shown in figure 16.

Using the current cycle shown in figure 16, the electrical offset is:

$$V_{OE} = \frac{V_{out}(t_1) + V_{out}(t_2)}{2}$$

The temperature variation V_{OT} of the electrical offset voltage V_{OE} is the variation of the electrical offset from 25 °C to the considered temperature:

Note: the transducer has to be demagnetized prior to the ap-

$$V_{OT}(T) = V_{OE}(T) - V_{OE}(25\text{ °C})$$

plication of the current cycle (for example with a demagnetization tunnel).

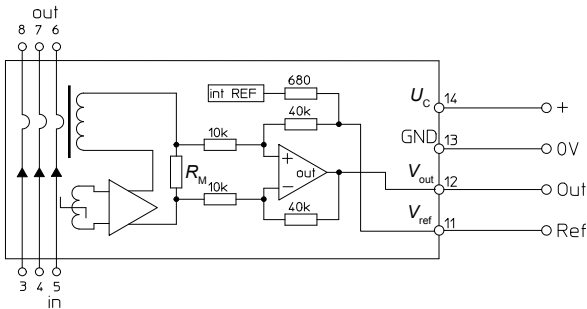

Figure 17: Test connection

Overall accuracy

The overall accuracy at 25 °C X_G is the error in the $-I_{PN} \dots +I_{PN}$ range, relative to the rated value I_{PN} .

It includes:

- the electrical offset V_{OE}
- the sensitivity error ϵ_G
- the linearity error ϵ_L (to I_{PN})

The magnetic offset is part of the overall accuracy. It is taken into account in the linearity error figure provided the transducer has not been magnetized by a current higher than I_{PN} .

Response and reaction times

The response time t_r and the reaction time t_{ra} are shown in figure 18.

Both depend on the primary current di/dt . They are measured at nominal ampere-turns.

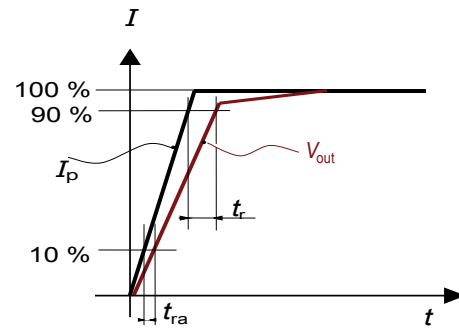

Figure 18: Response time t_r and reaction time t_{ra}

Application information

Filtering and decoupling

Supply voltage V_C

The fluxgate oscillator draws current pulses of up to 30 mA at a rate of ca. 900 kHz. Significant 900 kHz voltage ripple on V_C can indicate a power supply with high impedance. At these frequencies the power supply rejection ratio is low, and the ripple may appear on the transducer output V_{out} and reference V_{ref} . The transducer has internal decoupling capacitors, but in the case of a power supply with high impedance, it is advised to provide local decoupling (100 nF or more, located close to the transducer).

Output V_{out}

The output V_{out} has a very low output impedance of typically 2 Ohms; it can drive 100 pF directly. Adding series $R_f = 100$ Ohms allows much larger capacitive loads. Empirical evaluation may be necessary to obtain optimum results. The minimum load resistance on V_{out} is 1 kOhm.

Total Primary Resistance

The primary resistance is 0.72 mΩ per conductor.

In the following table, examples of primary resistance according to the number of primary turns.

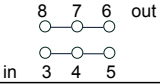
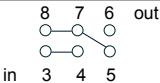
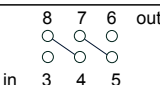
Number of primary turns	Primary resistance R_p [mΩ]	Recommended connections
1	0.18	
2	1.08	
3	2.16	

Reference V_{ref}

Ripple present on the reference output can be filtered with a low value of capacitance because of the internal 680 Ohm series resistance. The maximum filter capacitance value is 1 μF.

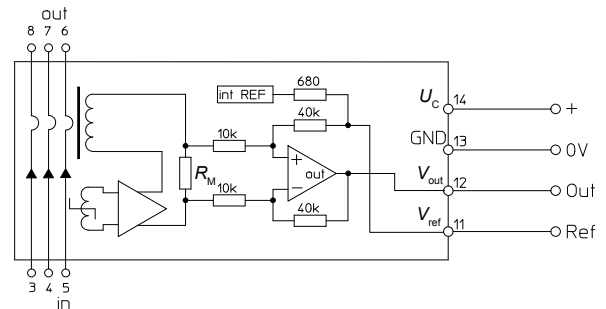

External reference voltage

If the Ref pin of the transducer is not used it could be either left unconnected or filtered according to the previous paragraph "Reference V_{ref} ".

The Ref pin has two modes Ref IN and Ref OUT:

- In the Ref OUT mode the 2.5 V internal precision reference is used by the transducer as the reference point for bipolar measurements; this internal reference is connected to the Ref pin of the transducer through a 680 Ohms resistor. It tolerates sink or source currents up to ± 5 mA, but the 680 Ohms resistor prevents this current to exceed these limits.
- In the Ref IN mode, an external reference voltage is connected to the Ref pin; this voltage is specified in the range 0 to 4 V and is directly used by the transducer as the reference point for measurements. The external reference voltage V_{ref} must be able:

- either to source a typical current of $\frac{V_{ref} - 2.5}{680}$, the maximum value will be 2.2 mA typ. when $V_{ref} = 4$ V.

- or to sink a typical current of $\frac{2.5 - V_{ref}}{680}$, the maximum value will be 3.68 mA typ. when $V_{ref} = 0$ V.

The following graphs show how the measuring range of each transducer version depends on the external reference voltage value V_{ref} .

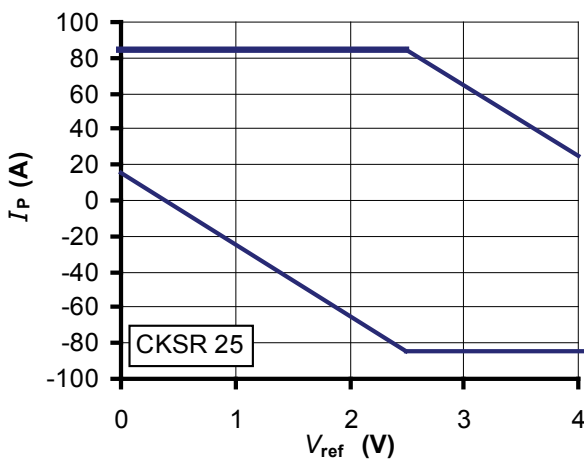

Upper limit: $I_p = -40 * V_{ref} + 185$ ($V_{ref} = 2.5 \dots 4$ V)
 Upper limit: $I_p = 85$ ($V_{ref} = 0 \dots 2.5$ V)
 Lower limit: $I_p = -40 * V_{ref} + 15$ ($V_{ref} = 0 \dots 2.5$ V)
 Lower limit: $I_p = -85$ ($V_{ref} = 2.5 \dots 4$ V)

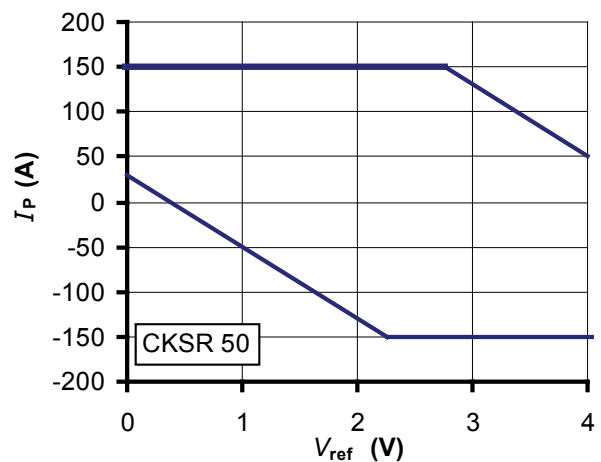

Upper limit: $I_p = -80 * V_{ref} + 370$ ($V_{ref} = 2.75 \dots 4$ V)
 Upper limit: $I_p = 150$ ($V_{ref} = 0 \dots 2.75$ V)
 Lower limit: $I_p = -80 * V_{ref} + 30$ ($V_{ref} = 0 \dots 2.75$ V)
 Lower limit: $I_p = -150$ ($V_{ref} = 2.75 \dots 4$ V)

Example with $V_{ref} = 1.65$ V:

- The 25 A version has a measuring range from -51 A to +85 A
- The 50 A version has a measuring range from -102 A to +150 A

Example with $V_{ref} = 0$ V:

- The 25 A version has a measuring range from +15 A to +85 A
- The 50 A version has a measuring range from +30 A to +150 A

Dimensions (in mm, general linear tolerance ± 0.25 mm)
