

For the electronic measurement of current: DC, AC, pulsed..., with galvanic separation between the primary and the secondary circuit.

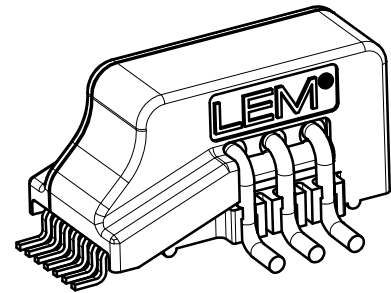

Features

- Hall effect measuring principle
- Multirange current transducer through PCB pattern lay-out
- Galvanic separation between primary and secondary circuit
- Insulated test voltage 4300 V
- Low power consumption
- Extremely low profile 12 mm
- Fixed offset & sensitivity
- Overcurrent detection $2.63 \times I_{PN}$ (peak value)
- Memory check.

Special feature

- Single power supply 3.3 V.

Advantages

- Small size and space saving
- Only one design for wide primary current range
- High immunity to external interference
- 8 mm creepage/clearance
- Fast response.

Applications

- AC variable speed drives
- Static converters for DC motor drives
- Battery supplied applications
- Uninterruptible Power Supplies (UPS)
- Switched Mode Power Supplies (SMPS)
- Power supplies for welding applications
- The solar inverter on DC side of the inverter (MPPT)
- Combiner box.

Standards

- EN 50178: 1997
- IEC 61010-1: 2010
- IEC 61326-1: 2012
- UL 508: 2018.

Application Domain

- Industrial.

Safety



Caution

If the device is used in a way that is not specified by the manufacturer, the protection provided by the device may be compromised. Always inspect the electronics unit and connecting cable before using this product and do not use it if damaged. Mounting assembly shall guarantee the maximum primary conductor temperature, fulfill clearance and creepage distance, minimize electric and magnetic coupling, and unless otherwise specified can be mounted in any orientation.



Caution, risk of electrical shock

This transducer must be used in limited-energy secondary circuits SELV according to IEC 61010-1, in electric/electronic equipment with respect to applicable standards and safety requirements in accordance with the manufacturer's operating specifications.

Use caution during installation and use of this product; certain parts of the module can carry hazardous voltages and high currents (e.g. power supply, primary conductor).

Ignoring this warning can lead to injury and or/or cause serious damage.

De-energize all circuits and hazardous live parts before installing the product.

All installations, maintenance, servicing operations and use must be carried out by trained and qualified personnel practicing applicable safety precautions.

This transducer is a build-in device, whose hazardous live parts must be inaccessible after installation.

This transducer must be mounted in a suitable end-enclosure.

Besides make sure to have a distance of minimum 30 mm between the primary terminals of the transducer and other neighboring components.

Main supply must be able to be disconnected.

Never connect or disconnect the external power supply while the primary circuit is connected to live parts.

Always wear protective clothing and gloves if hazardous live parts are present in the installation where the measurement is carried out.

This transducer is a built-in device, not intended to be cleaned with any product. Nevertheless if the user must implement cleaning or washing process, validation of the cleaning program has to be done by himself.



ESD susceptibility

The product is susceptible to be damaged from an ESD event and the personnel should be grounded when handling it.

Do not dispose of this product as unsorted municipal waste. Contact a qualified recycler for disposal.

Although LEM applies utmost care to facilitate compliance of end products with applicable regulations during LEM product design, use of this part may need additional measures on the application side for compliance with regulations regarding EMC and protection against electric shock. Therefore LEM cannot be held liable for any potential hazards, damages, injuries or loss of life resulting from the use of this product.



Underwriters Laboratory Inc. recognized component

Absolute maximum ratings

Parameter	Symbol	Unit	Value
Maximum supply voltage	$U_{C \max}$	V	6.5
Maximum primary conductor temperature	$T_{B \max}$	°C	120
Electrostatic discharge voltage (HBM - Human Body Model)	$U_{ESD \text{ HBN}}$	kV	2

Stresses above these ratings may cause permanent damage. Exposure to absolute maximum ratings for extended periods may degrade reliability.

UL 508: Ratings and assumptions of certification

File # E189713 Volume: 2 Section: 5

Standards

- CSA C22.2 NO. 14-10 INDUSTRIAL CONTROL EQUIPMENT - Edition 11
- UL 508 STANDARD FOR INDUSTRIAL CONTROL EQUIPMENT - Edition 18

Ratings

Parameter	Unit	Value
Primary potential involved ¹⁾	V AC/DC	1000
Maximum surrounding air temperature	°C	105
Primary current	A	According to series primary currents
Transducer supply voltage	V DC	0 ... 3.3
Output voltage	V	0 ... 3.3

Note: ¹⁾ Primary potential involved is 600 V AC/DC according to Canadian Standard CSA C22.2.

Conditions of acceptability

When installed in the end-use equipment, consideration shall be given to the following:

- 1 - These devices have been evaluated for overvoltage category III and for use in pollution degree 2 environment.
- 2 - A suitable enclosure shall be provided in the end-use application.
- 3 - The terminals have not been evaluated for field wiring.
- 4 - These devices have been evaluated for use in 105 °C maximum surrounding air temperature.
- 5 - The secondary (Sensing) circuit is intended to be supplied by an Isolated Secondary Circuit - Limited voltage circuit defined by UL 508 paragraph 32.5. The maximum open circuit voltage potential available to the circuit and overcurrent protection shall be evaluated in the end use application.
- 6 - These devices are intended to be mounted on a printed wiring board of end-use equipment. The suitability of the connections (including spacings) shall be determined in the end-use application.
- 7 - Primary terminals shall not be straightened since assembly of housing case depends upon bending of the terminals.
- 8 - Any surface of polymeric housing have not been evaluated as insulating barrier.
- 9 - Low voltage circuits are intended to be powered by a circuit derived from an isolating source (such as a transformer, optical isolator, limiting impedance or electro-mechanical relay) and having no direct connection back to the primary circuit (other than through the grounding means).

Marking

Only those products bearing the UL or UR Mark should be considered to be Listed or Recognized and covered under UL's Follow-Up Service. Always look for the Mark on the product.

Insulation coordination

Parameter	Symbol	Unit	Value	Comment
RMS voltage for AC insulation test, 50/60 Hz, 1 min	U_d	kV	4.3	
Impulse withstand voltage 1.2/50 μ s	U_{Ni}	kV	8	
Partial discharge extinction test voltage ($q_m < 10$ pC)	U_t	V	1650	
Clearance (pri. - sec.)	d_{Cl}	mm	8	Shortest distance through air
Creepage distance (pri. - sec.)	d_{Cp}	mm	8	Shortest path along device body
Case material	-	-	V0	According to UL 94
Comparative tracking index	CTI		600	
Application example		V	600	Reinforced insulation, CAT III, PD 2 non uniform field according to EN 50178
Application example		V	300	Reinforced insulation, CAT III, PD 2 non uniform field according to IEC 61010
Application example		V	1000	Basic insulation, CAT III, PD 2 non uniform field according to EN 50178, IEC 61010

Environmental and mechanical characteristics

Parameter	Symbol	Unit	Min	Typ	Max	Comment
Ambient operating temperature	T_A	$^{\circ}$ C	-40		105	
Ambient storage temperature	$T_{A\ st}$	$^{\circ}$ C	-40		105	
Surrounding temperature according to UL 508		$^{\circ}$ C			105	
Mass	m	g		5		

At $T_A = 25\text{ °C}$, $U_C = +3.3\text{ V}$, $N_P = 1\text{ turn}$, $R_L = 10\text{ K}\Omega$ unless otherwise noted (see Min, Max, typ. definition paragraph in [page 8](#)).

Parameter	Symbol	Unit	Min	Typ	Max	Comment
Primary nominal RMS current	I_{PN}	At		8		
Primary current, measuring range	I_{PM}	At	-20		20	
Number of primary turns	N_P			1,2,3		
Supply voltage	U_C	V	3.14	3.3	3.46	
Current consumption	I_C	mA			25	
Reference voltage	U_{ref}	V	1.636	1.65	1.664	Internal reference
External reference voltage	U_{ref}	V	0.5		1.85	@ $U_C = 3.3 \approx 3.46\text{ V}$
			0.5		1.7	@ $U_C = 3.14 \approx 3.3\text{ V}$
Output voltage range @ I_{PM}	$U_{out} - U_{ref}$	V	-1.15		1.15	
Output voltage @ $I_P = 0\text{ A}$	U_{out}	V		$U_{ref} + U_{OE}$		
Electrical offset voltage	U_{OE}	mV	-7		7	
Temperature coefficient of U_{ref}	TCU_{ref}	ppm/K			± 170	-20 °C ... 85 °C Internal reference
					± 180	-40 °C ... 105 °C Internal reference
Temperature coefficient of U_{OE}	TCU_{OE}	mV/K			± 0.080	-40 °C ... 105 °C
Nominal sensitivity	S_N	mV/A		57.5		460 mV/ I_{PN} @ $U_C = 3.3\text{ V}$
Sensitivity error	ε_S	%			± 0.5	Factory adjustment
Temperature coefficient of S	TCS	ppm/K			± 200	-20 °C ... 85 °C
					± 210	-40 °C ... 105 °C
Linearity error 0 ... I_{PN}	ε_L	% of I_{PN}			± 0.5	@ $U_C = 3.3\text{ V}$
Linearity error 0 ... I_{PM}	ε_L	% of I_{PM}			± 0.8	@ $U_C = 3.3\text{ V}$
Sensitivity error with respect to $U_C \pm 10\%$	ε_S	%/%			± 0.05	Sensitivity error per U_C drift
Magnetic offset voltage @ $I_P = 0$ after $2.5 \times I_{PN}$	U_{OM}	mV			± 4	
Delay time @ 10 % of the final output value I_{PN} step	t_{D10}	μs			2	$di/dt = I_{PN}/\mu\text{s}$
Delay time @ 90 % of the final output value I_{PN} step	t_{D90}	μs			3.5	$di/dt = I_{PN}/\mu\text{s}$
Frequency bandwidth (-3 dB)	BW	kHz		250		
Noise voltage spectral density (DC ... 100 kHz)	u_{no}	$\mu\text{V}/\text{Hz}$			18.9	
RMS noise voltage (DC ... 20 MHz)	U_{no}	mVpp		40		
Standby pin "0" level		V			0.3	
Standby pin "1" level		V	$U_C - 0.3$			
Time to switch from standby to normal mode		μs			20	
Overcurrent detection		At	$2.6 \times I_{PN}$	$2.9 \times I_{PN}$	$3.2 \times I_{PN}$	peak value
Sum of sensitivity and linearity error @ I_{PN}	ε_{SL}	% of I_{PN}			± 1	$= \varepsilon_S + \varepsilon_L$
Sum of sensitivity and linearity error @ I_{PN} @ $T_A = +85\text{ °C}$	ε_{SL85}	% of I_{PN}			± 3.3	See formula note ¹⁾
Sum of sensitivity and linearity error @ I_{PN} @ $T_A = +105\text{ °C}$	ε_{SL105}	% of I_{PN}			± 4.1	See formula note ¹⁾

Note: ¹⁾ Error @ I_P and $T_A = \pm [\varepsilon_{SL} + (TCS/10000) \cdot (T_A - 25) + TCU_{OE} \cdot 100 \cdot (T_A - 25) / (S_N \cdot I_P)]$.

At $T_A = 25\text{ °C}$, $U_C = +3.3\text{ V}$, $N_P = 1$ turn, $R_L = 10\text{ K}\Omega$ unless otherwise noted (see Min, Max, typ. definition paragraph in [page 8](#)).

Parameter	Symbol	Unit	Min	Typ	Max	Comment
Primary nominal RMS current	I_{PN}	At		15		
Primary current, measuring range	I_{PM}	At	-37.5		37.5	
Number of primary turns	N_P			1,2,3		
Supply voltage	U_C	V	3.14	3.3	3.46	
Current consumption	I_C	mA			25	
Reference voltage	U_{ref}	V	1.636	1.65	1.664	Internal reference
External reference voltage	U_{ref}	V	0.5		1.85	@ $U_C = 3.3 \approx 3.46\text{ V}$
			0.5		1.7	@ $U_C = 3.14 \approx 3.46\text{ V}$
Output voltage range @ I_{PM}	$U_{out} - U_{ref}$	V	-1.15		1.15	
Output voltage @ $I_P = 0\text{ A}$	U_{out}	V		$U_{ref} + U_{OE}$		
Electrical offset voltage	U_{OE}	mV	-5		5	
Temperature coefficient of U_{ref}	TCU_{ref}	ppm/K			± 170	-20 °C ... 85 °C Internal reference
					± 180	-40 °C ... 105 °C Internal reference
Temperature coefficient of U_{OE}	TCU_{OE}	mV/K			± 0.080	-40 °C ... 105 °C
Nominal sensitivity	S_N	mV/A		30.67		460 mV / I_{PN} @ $U_C = 3.3\text{ V}$
Sensitivity error	ϵ_S	%			± 0.5	Factory adjustment
Temperature coefficient of S	TCS	ppm/K			± 200	-20 °C ... 85 °C
					± 210	-40 °C ... 105 °C
Linearity error 0 ... I_{PN}	ϵ_L	% of I_{PN}			± 0.5	@ $U_C = 3.3\text{ V}$
Linearity error 0 ... I_{PM}	ϵ_L	% of I_{PM}			± 0.8	@ $U_C = 3.3\text{ V}$
Sensitivity error with respect to $U_C \pm 10\%$	ϵ_S	%/%			± 0.4	Sensitivity error per U_C drift
Magnetic offset voltage @ $I_P = 0$ after $2.5 \times I_{PN}$	U_{OM}	mV			± 4	
Delay time @ 10 % of the final output value I_{PN} step	t_{D10}	μs			2	$di/dt = I_{PN}/\mu\text{s}$
Delay time @ 90 % of the final output value I_{PN} step	t_{D90}	μs			3.5	$di/dt = I_{PN}/\mu\text{s}$
Frequency bandwidth (-3 dB)	BW	kHz		250		
Noise voltage spectral density (DC ... 100 kHz)	u_{no}	$\mu\text{V}/\text{Hz}$			10.15	
RMS noise voltage (DC ... 20 MHz)	U_{no}	mVpp		30		
Standby pin "0" level		V			0.3	
Standby pin "1" level		V	$U_C - 0.3$			
Time to switch from standby to normal mode		μs			20	
Overcurrent detection		At	$2.6 \times I_{PN}$	$2.9 \times I_{PN}$	$3.2 \times I_{PN}$	peak value
Sum of sensitivity and linearity error @ I_{PN}	ϵ_{SL}	% of I_{PN}			± 1	$= \epsilon_S + \epsilon_L$
Sum of sensitivity and linearity error @ I_{PN} @ $T_A = +85\text{ °C}$	ϵ_{SL85}	% of I_{PN}			± 3.3	See formula note ¹⁾
Sum of sensitivity and linearity error @ I_{PN} @ $T_A = +105\text{ °C}$	ϵ_{SL105}	% of I_{PN}			± 4.1	See formula note ¹⁾

Note: ¹⁾ Error @ I_P and $T_A = \pm [\epsilon_{SL} + (TCS/10000) \cdot (T_A - 25) + TCU_{OE} \cdot 100 \cdot (T_A - 25) / (S_N \cdot I_P)]$.

At $T_A = 25\text{ °C}$, $U_C = +3.3\text{ V}$, $N_p = 1\text{ turn}$, $R_L = 10\text{ K}\Omega$ unless otherwise noted (see Min, Max, typ. definition paragraph in [page 8](#)).

Parameter	Symbol	Unit	Min	Typ	Max	Comment
Primary nominal RMS current	I_{PN}	At		25		
Primary current, measuring range	I_{PM}	At	-62.5		62.5	
Number of primary turns	N_p			1,2,3		
Supply voltage	U_C	V	3.14	3.3	3.46	
Current consumption	I_C	mA			25	
Reference voltage	U_{ref}	V	1.636	1.65	1.664	Internal reference
External reference voltage	U_{ref}	V	0.5		1.85	@ $U_C = 3.3 \approx 3.46\text{ V}$
			0.5		1.7	@ $U_C = 3.14 \approx 3.3\text{ V}$
Output voltage range @ I_{PM}	$U_{out} - U_{ref}$	V	-1.15		1.15	
Output voltage @ $I_p = 0\text{ A}$	U_{out}	V		$U_{ref} + U_{OE}$		
Electrical offset voltage	U_{OE}	mV	-6		6	
Temperature coefficient of U_{ref}	TCU_{ref}	ppm/K			± 170	-20 °C ... 85 °C Internal reference
					± 180	-40 °C ... 105 °C Internal reference
Temperature coefficient of U_{OE}	TCU_{OE}	mV/K			± 0.080	-40 °C ... 105 °C
Nominal sensitivity	S_N	mV/A		18.4		460 mV/ I_{PN} @ $U_C = 3.3\text{ V}$
Sensitivity error	ϵ_s	%			± 0.5	Factory adjustment
Temperature coefficient of S	TCS	ppm/K			± 200	-20 °C ... 85 °C
					± 210	-40 °C ... 105 °C
Linearity error 0 ... I_{PN}	ϵ_L	% of I_{PN}			± 0.5	@ $U_C = 3.3\text{ V}$
Linearity error 0 ... I_{PM}	ϵ_L	% of I_{PM}			± 0.8	@ $U_C = 3.3\text{ V}$
Sensitivity error with respect to $U_C \pm 10\%$	ϵ_s	%/%			± 0.4	Sensitivity error per U_C drift
Magnetic offset voltage @ $I_p = 0$ after $2.5 \times I_{PN}$	U_{OM}	mV			± 4	
Delay time @ 10 % of the final output value I_{PN} step	t_{D10}	μs			2	$di/dt = I_{PN}/\mu\text{s}$
Delay time @ 90 % of the final output value I_{PN} step	t_{D90}	μs			3.5	$di/dt = I_{PN}/\mu\text{s}$
Frequency bandwidth (-3 dB)	BW	kHz		250		
Noise voltage spectral density (DC ... 100 kHz)	u_{no}	$\mu\text{V}/\text{Hz}^{1/2}$			6.13	
RMS noise voltage (DC ... 20 MHz)	U_{no}	mVpp		20		
Standby pin "0" level		V			0.3	
Standby pin "1" level		V	$U_C - 0.3$			
Time to switch from standby to normal mode		μs			20	
Overcurrent detection		At	$2.6 \times I_{PN}$	$2.9 \times I_{PN}$	$3.2 \times I_{PN}$	peak value
Sum of sensitivity and linearity error @ I_{PN}	ϵ_{SL}	% of I_{PN}			± 1	$= \epsilon_s + \epsilon_L$
Sum of sensitivity and linearity error @ I_{PN} @ $T_A = +85\text{ °C}$	ϵ_{SL85}	% of I_{PN}			± 3.3	See formula note ¹⁾
Sum of sensitivity and linearity error @ I_{PN} @ $T_A = +105\text{ °C}$	ϵ_{SL105}	% of I_{PN}			± 4.1	See formula note ¹⁾

Note: ¹⁾ Error @ I_p and $T_A = \pm [\epsilon_{SL} + (TCS/10000) \cdot (T_A - 25) + TCU_{OE} \cdot 100 \cdot (T_A - 25) / (S_N \cdot I_p)]$.

Page 7/19

Definition of typical, minimum and maximum values

Minimum and maximum values for specified limiting and safety conditions have to be understood as such as well as values shown in “typical” graphs.

On the other hand, measured values are part of a statistical distribution that can be specified by an interval with upper and lower limits and a probability for measured values to lie within this interval.

Unless otherwise stated (e.g. “100 % tested”), the LEM definition for such intervals designated with “min” and “max” is that the probability for values of samples to lie in this interval is 99.73 %.

For a normal (Gaussian) distribution, this corresponds to an interval between -3 sigma and $+3$ sigma. If “typical” values are not obviously mean or average values, those values are defined to delimit intervals with a probability of 68.27 %, corresponding to an interval between $-\text{sigma}$ and $+\text{sigma}$ for a normal distribution.

Typical, maximal and minimal values are determined during the initial characterization of a product.

Typical performance characteristics $I_{PN} = 8\text{ A}$

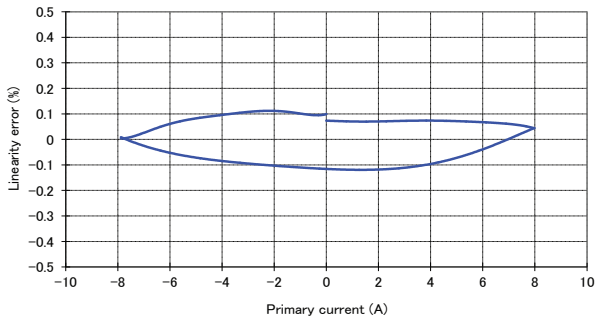

Figure 1: Linearity error

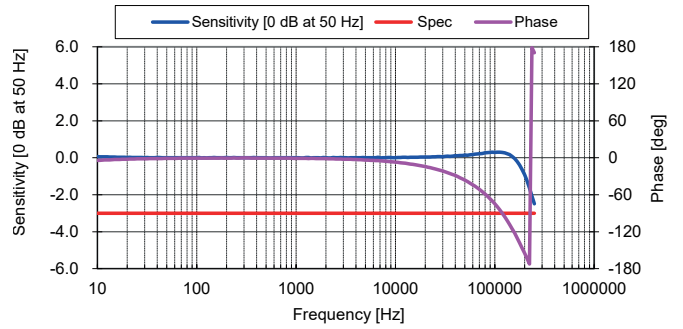

Figure 2: Frequency response

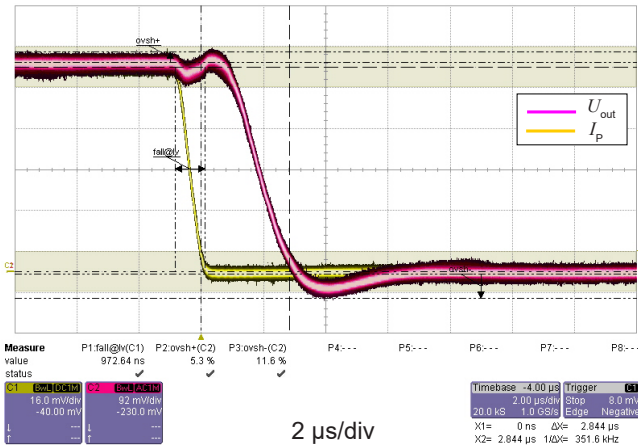

Figure 3: Step response

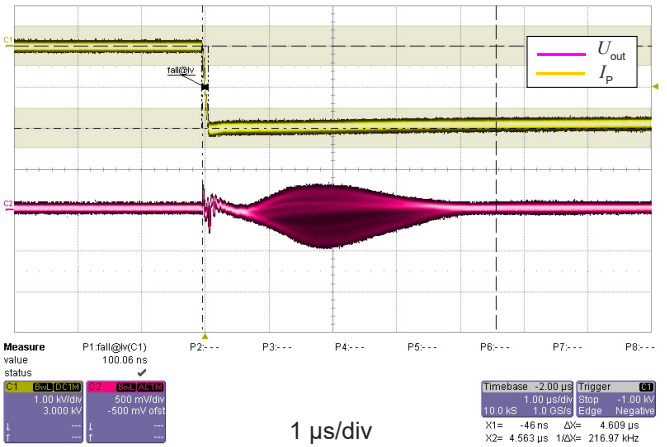

Figure 4: dv/dt

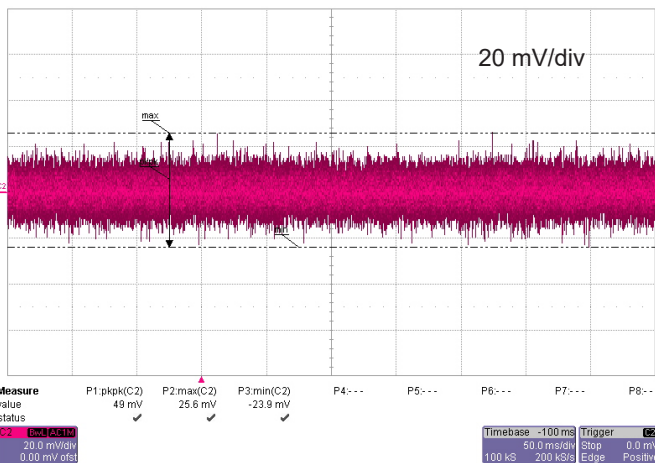

Figure 5: Output noise

Typical performance characteristics $I_{PN} = 15\text{ A}$

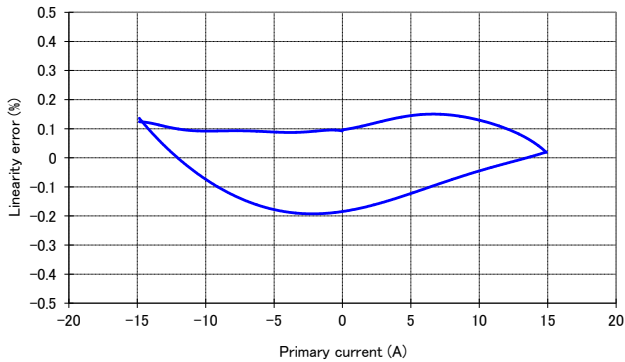

Figure 6: Linearity error

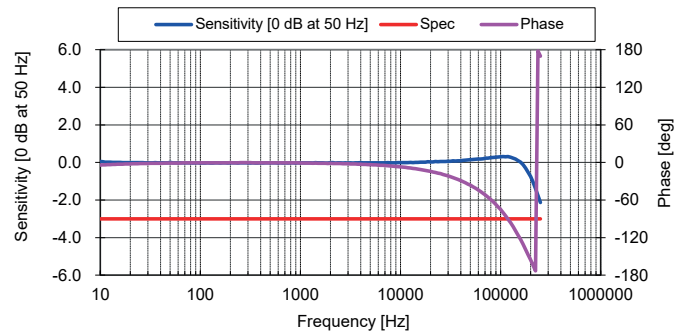

Figure 7: Frequency response

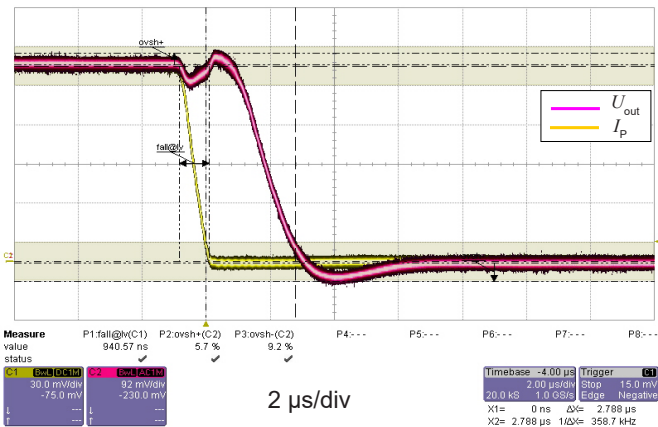

Figure 8: Step response

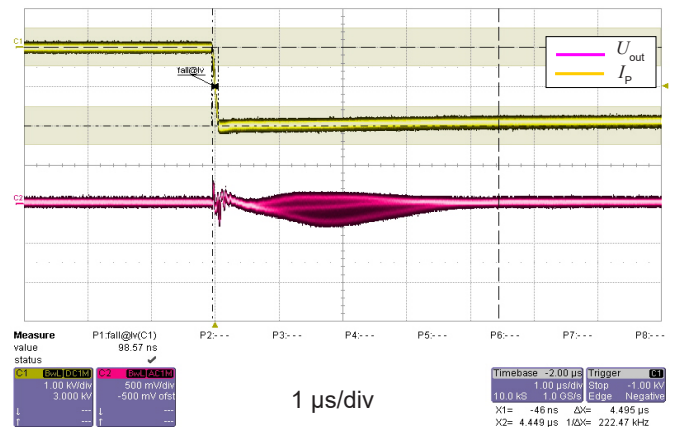

Figure 9: dv/dt

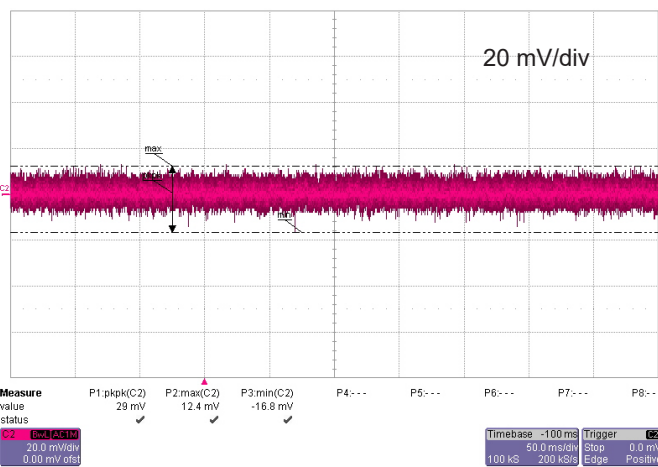

Figure 10: Output noise

Typical performance characteristics $I_{PN} = 25\text{ A}$

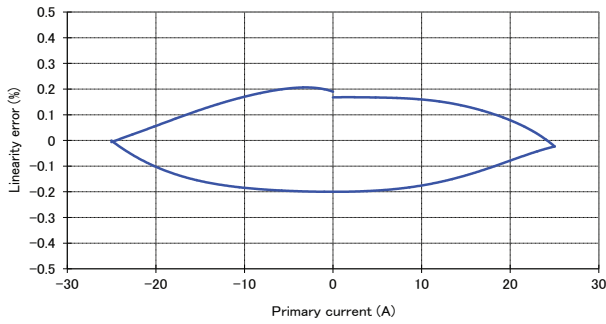

Figure 11: Linearity error

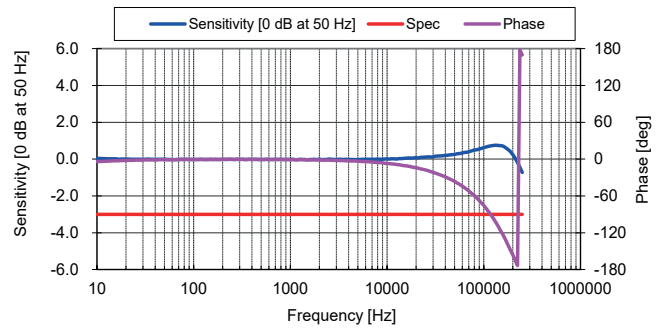

Figure 12: Frequency response

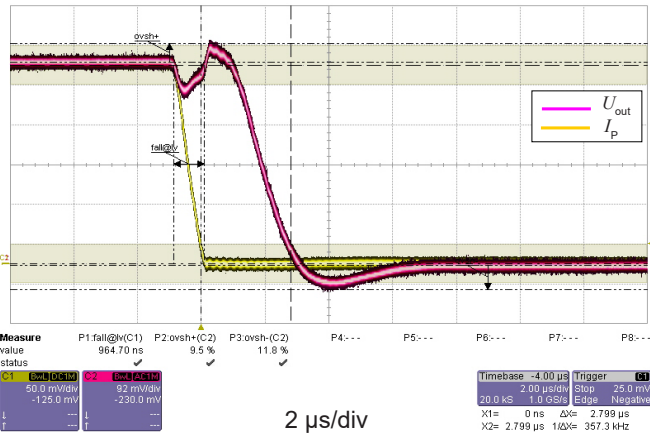

Figure 13: Step response

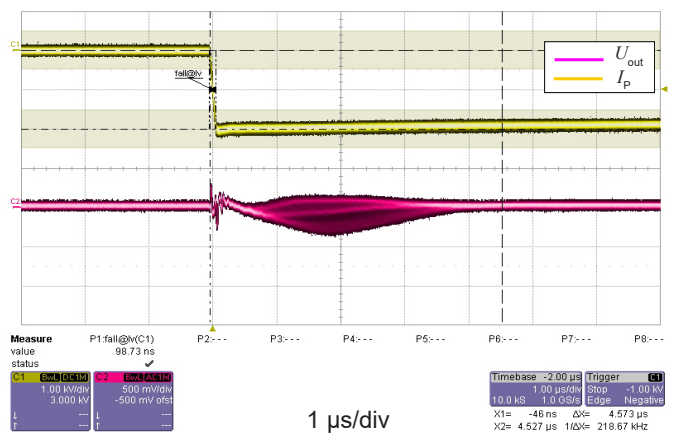

Figure 14: dv/dt

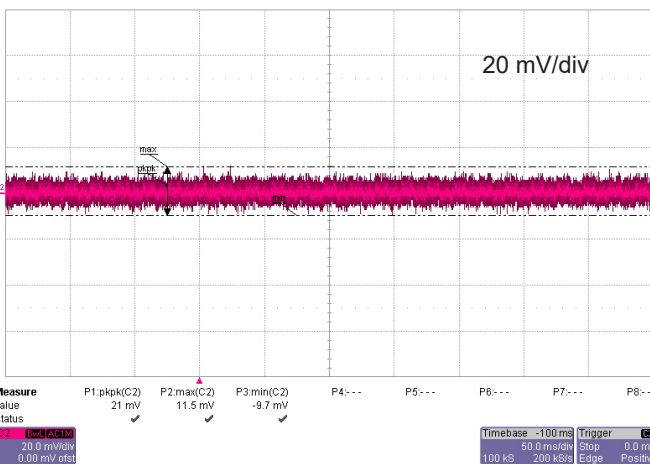

Figure 15: Output noise

Maximum continuous DC primary current

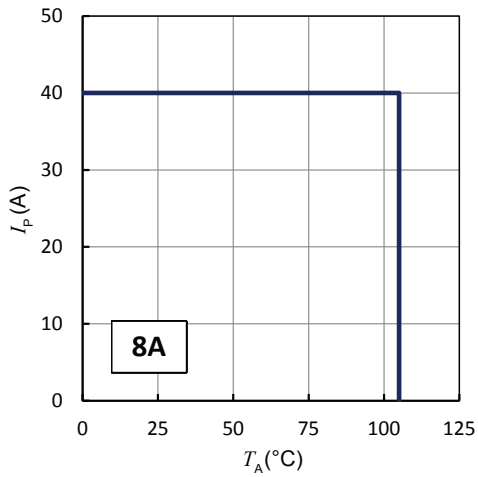

Figure 16: I_p vs T_A for HO series

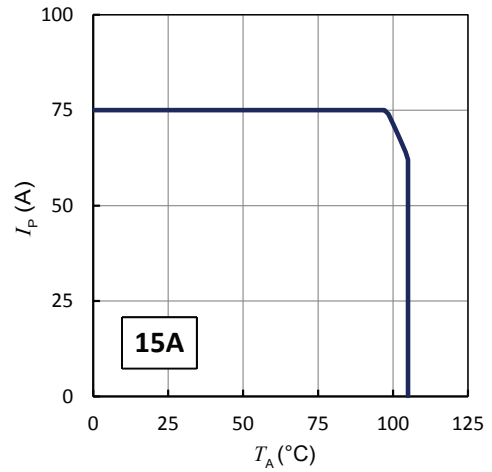

Figure 17: I_p vs T_A for HO series

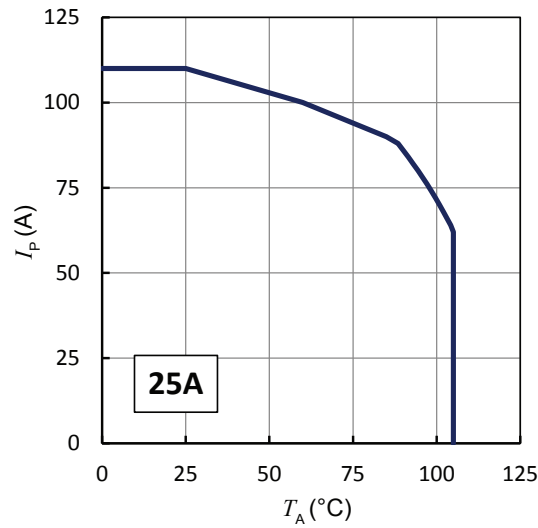
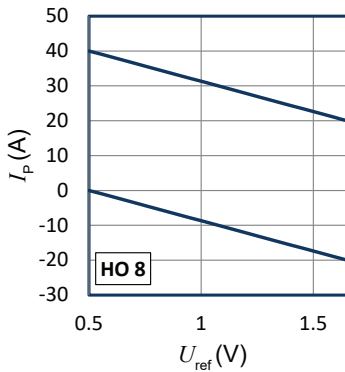

Figure 18: I_p vs T_A for HO series

Important notice: whatever the usage and/or application, the transducer jumper temperature shall not go above the maximum rating of 120 °C as stated in [page 3](#) of this datasheet.

Measuring range with external reference voltage



Upper limit: $I_p = 17.39 \times U_{ref} + 48.7$ ($U_{ref} = 0.5 \dots 1.65$ V)

Lower limit: $I_p = 17.39 \times U_{ref} + 8.7$ ($U_{ref} = 0.5 \dots 1.65$ V)

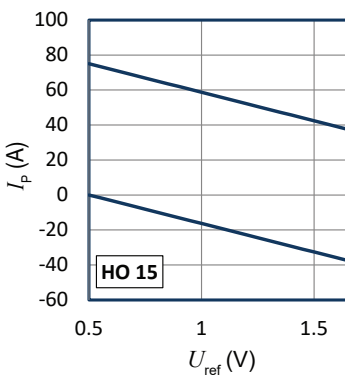

Upper limit: $I_p = -32.81 \times U_{ref} + 91.3$ ($U_{ref} = 0.5 \dots 1.65$ V)

Lower limit: $I_p = -32.81 \times U_{ref} + 16.3$ ($U_{ref} = 0.5 \dots 1.65$ V)

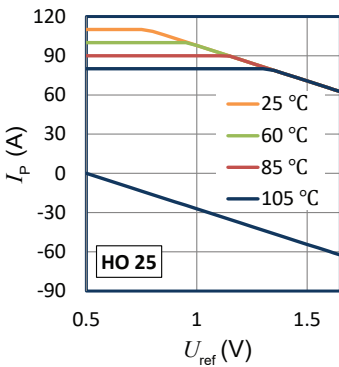

Upper limit:

$T_A = 105 \text{ °C}$ $I_p = 80$ ($U_{ref} = 0.5 \dots 1.328$ V)
 $I_p = -54.35 \times U_{ref} + 152.17$ ($U_{ref} = 1.328 \dots 1.65$ V)

$T_A = 85 \text{ °C}$ $I_p = 90$ ($U_{ref} = 0.5 \dots 1.144$ V)
 $I_p = -54.35 \times U_{ref} + 152.17$ ($U_{ref} = 1.144 \dots 1.65$ V)

$T_A = 80 \text{ °C}$ $I_p = 100$ ($U_{ref} = 0.5 \dots 0.96$ V)
 $I_p = -54.35 \times U_{ref} + 152.17$ ($U_{ref} = 0.96 \dots 1.65$ V)

$T_A = 25 \text{ °C}$ $I_p = 110$ ($U_{ref} = 0.5 \dots 0.776$ V)
 $I_p = -54.35 \times U_{ref} + 152.17$ ($U_{ref} = 0.776 \dots 1.65$ V)

Lower limit: $I_p = -54.35 \times U_{ref} + 27.17$ ($U_{ref} = 0.5 \dots 1.65$ V)

Example with $U_{ref} = 0.5$ V:

- The 8 A version has a measuring range from 0 A to 40 A
- The 15 A version has a measuring range from 0 A to 75 A
- The 25 A version has a measuring range from 0 A to 80 A at $T_A = 105 \text{ °C}$

Example with $U_{ref} = 1.5$ V:

- The 8 A version has a measuring range from -17.4 A to + 22.6 A
- The 15 A version has a measuring range from -32.6 A to + 42.4 A
- The 25 A version has a measuring range from -54.4 A to + 70.6 A

Terms and definitions

Ampere-turns and amperes

The transducer is sensitive to the primary current linkage θ_p (also called ampere-turns).

$$\theta_p = N_p \cdot I_p$$

Where N_p is the number of primary turn (depending on the connection of the primary jumpers).

Caution: As most applications will use the transducer with only one single primary turn ($N_p = 1$), much of this datasheet is written in terms of primary current instead of current linkages. However, the ampere-turns (A) unit is used to emphasis that current linkages are intended and applicable.

Simplified transducer model

The static model of the transducer with voltage output at temperature T_A is:

$$U_{out} = S \cdot \theta_p (1 + \varepsilon)$$

In which (referred to primary):

$$\varepsilon \cdot \theta_p = U_{OE} + U_{OT} + \varepsilon_S \cdot \theta_p + \varepsilon_{ST} \cdot \theta_p + \varepsilon_L(\theta_{Pmax}) \cdot \theta_{Pmax} + I_{OM}$$

$\theta_p = N_p \cdot I_p$: primary current linkage (A)

θ_{Pmax} : maximum primary current linkage applied to the transducer

U_{out} : output voltage (V)

S : sensitivity of the transducer

T_A : ambient operating temperature ($^{\circ}\text{C}$)

U_{OE} : electrical offset voltage (A)

I_{OM} : magnetic offset current (A)

U_{OT} : temperature variation of U_{OE} (A)

ε_S : sensitivity error at 25°C

ε_{ST} : thermal drift of S

$\varepsilon_L(\theta_{Pmax})$: linearity error for θ_{Pmax}

This model is valid for primary ampere-turns θ_p between $-\theta_{Pmax}$ and $+\theta_{Pmax}$ only.

This is the absolute maximum error. As all errors are independent, a more realistic way to calculate the error would be to use the following formula:

$$\varepsilon = \sqrt{\sum_{i=1}^N \varepsilon_i^2}$$

Total error referred to primary

The total error ε_{tot} is the error at $\pm I_{PN}$, relative to the rated value I_{PN} .

It includes all errors mentioned above:

- the electrical offset U_{OE}
- the magnetic offset I_{OM}
- the sensitivity error ε_S
- the linearity error ε_L (to I_{PN}).

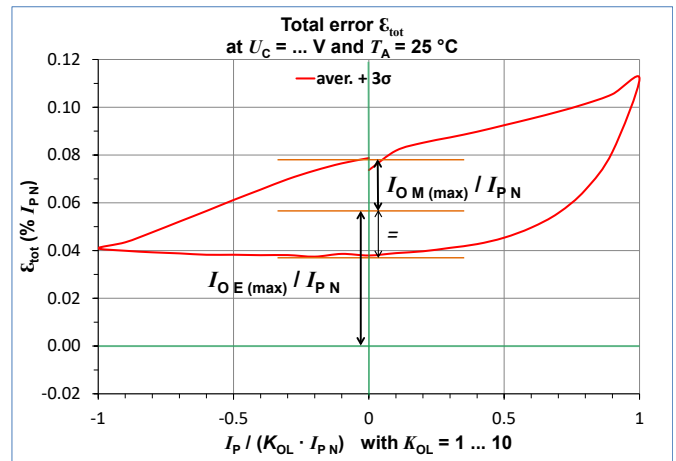

Figure 19: Total error ε_{tot}

Electrical offset referred to primary

Using the current cycle shown in figure 19, the electrical offset current I_{OE} is the residual output referred to primary when the input current is zero.

$$I_{OE} = \frac{I_{P(3)} + I_{P(5)}}{2}$$

The temperature variation I_{OT} of the electrical offset current I_{OE} is the variation of the electrical offset from 25°C to the considered temperature.

$$I_{OT}(T) = I_{OE}(T) - I_{OE}(25^{\circ}\text{C})$$

Magnetic offset referred to primary

The magnetic offset current I_{OM} is the consequence of a current on the primary side ("memory effect" of the transducer's ferromagnetic parts). It is measured using the following primary current cycle. I_{OM} depends on the current value $I_p \geq I_{PN}$.

K_{OL} : Overload factor

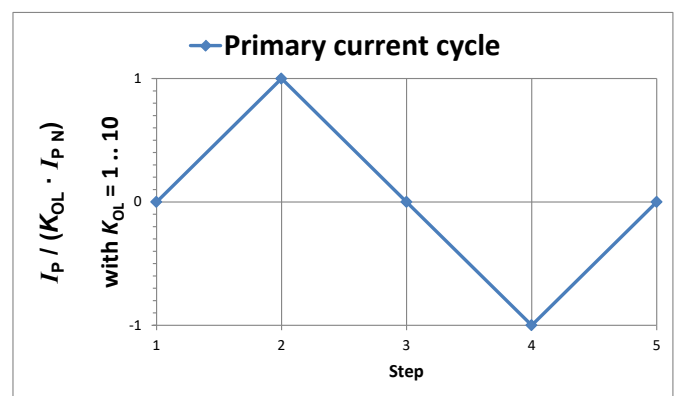

Figure 20: Current cycle used to measure magnetic and electrical offset (transducer supplied)

$$I_{OM} = \frac{I_{P(3)} - I_{P(5)}}{2}$$

Performance parameters definition

Sensitivity and linearity

To measure sensitivity and linearity, the primary current (DC) is cycled from 0 to I_P , then to $-I_P$ and back to 0 (equally spaced $I_F/10$ steps). The sensitivity S is defined as the slope of the linear regression line for a cycle between $\pm I_{PN}$.

The linearity error ε_L is the maximum positive or negative difference between the measured points and the linear regression line, expressed in % of I_{PN} .

Delay times

The delay time $t_{D,10}$ @ 10 % and the delay time $t_{D,90}$ @ 90 % with respect to the primary are shown in the next figure.

Both slightly depend on the primary current di/dt . They are measured at nominal current.

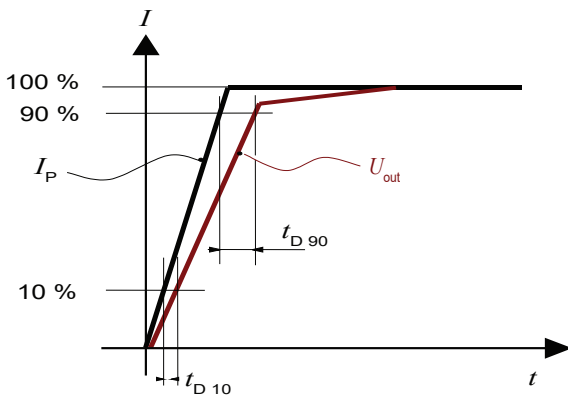

Figure 21 :Delay time $t_{D,90}$ @ 90 and delay time $t_{D,10}$ @10

Application information

Total primary resistance

The primary resistance is 0.36 mΩ per conductor at 25 °C.

In the following table, examples of primary resistance according to the number of primary turns.

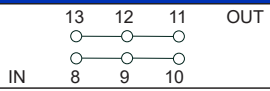
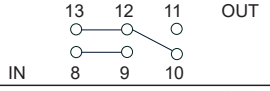
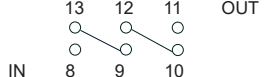
Number of primary turns N_P	Resistance of primary (winding) R_P [mΩ]	Recommended connections	Primary nominal RMS current $I_{P,N}$ [A]		
1	0.12		8	15	25
2	0.54		4	7.5	12.5
3	1.18		2.67	5	8.33

HO-NSM/SP33 Series: name and codification

HO family products may be ordered **on request** ¹⁾ with a dedicated setting of the parameters described below (standard products are delivered with the setting 1000 according to the table).

HO 15-NSM/SP33-XXXX

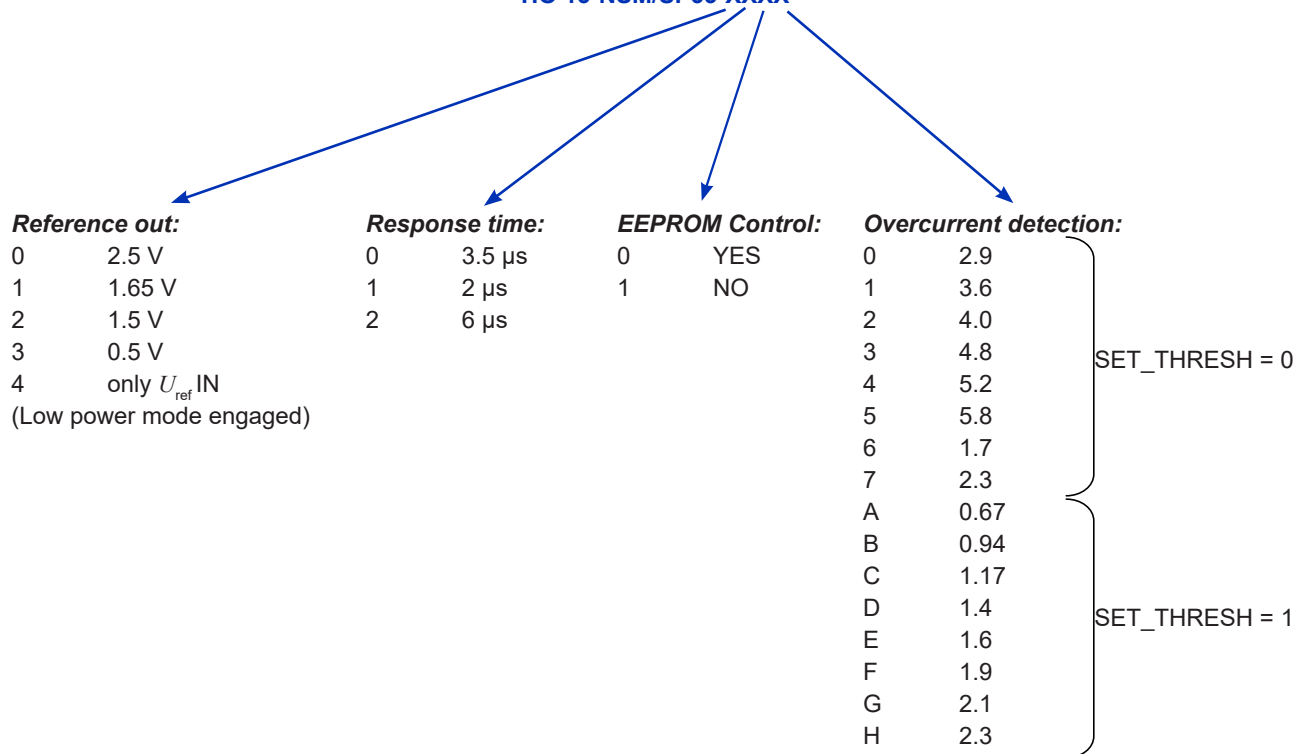

Standard products are:
 - HO 8-NSM/SP33-1000
 - HO 15-NSM/SP33-1000
 - HO 25-NSM/SP33-1000

Note: ¹⁾ For dedicated settings, minimum quantities apply.

PCB Footprint

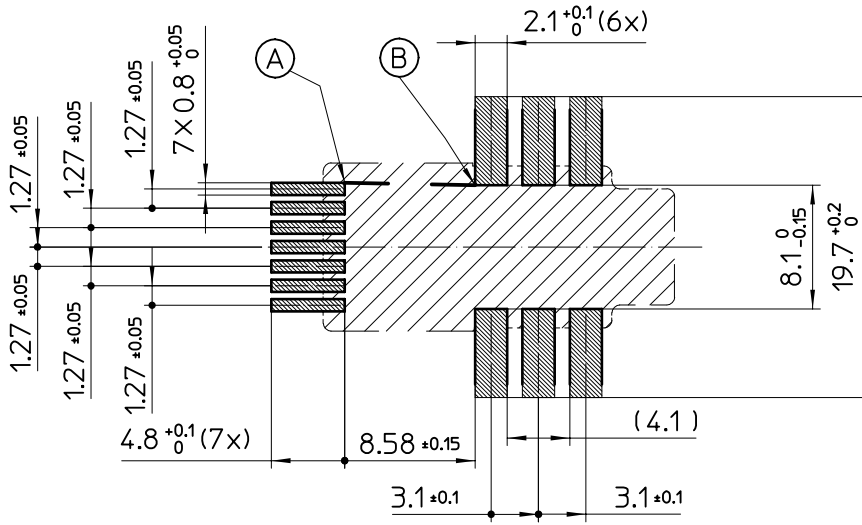

Dimensions HO 8-NSM/SP33, 15-NSM/SP33, 25-NSM/SP33 (in mm, general linear tolerance ± 0.5 mm)

Technical drawing showing dimensions and pin configurations for the HO-NSM/SP33 series transducer. Dimensions include 12, 1.27 ± 0.05 (6x), 3.1, 3.1, 3x18 ± 0.2 , 2, 23, 12.5 ± 0.4 , 10.7, 5.8, 15.1 ± 0.4 , (2.1), 5.3 ± 0.2 , and 7.6. Pin configurations are shown as 13, 12, 11, 8, 9, 10, 7, 5, 3, 1, 6, 4, 2, and A. A marking area is indicated with a diameter of 0.15 A. A table provides d_{Cl} (mm) and d_{Cp} (mm) values of 8.0. A note states: 1) Minimum distance from the primary to the core.

	d_{Cl} (mm)	d_{Cp} (mm)
note1)	8.0	8.0

1) Minimum distance from the primary to the core

Connection

Circuit diagram showing the internal transformer and op-amp circuit. The transformer has primary pins 10, 9, 8 and secondary pins 11, 12, 13. The op-amp circuit includes a 5Ω resistor, a 200Ω resistor, and a >10kΩ resistor. The output is connected to pins 1, 2, 3, 4, 5, 6, and 7. Component values include 47nF capacitors and a 5Ω resistor. The output is labeled +U_C, 0V, U_{out}, U_{ref} (IN/OUT), OCD, and STANDBY. Pin 7 is N/A (connected to ground).

Marking area:
 Model type
 Date code
 UL mark
 Current direction